

SM200A/B/C and SM435B/C Spectrum Analyzer Product Manual

Signal Hound SM200A/B/C – SM435B/C Product Manual

Published 9/1/2022
©2022, Signal Hound
1502 SE Commerce Ave, Suite 101
Battle Ground, WA
Phone 360-313-7997

This information is being released into the public domain in accordance with the Export Administration
Regulations 15 CFR 734

Contents

| | |
|---|-----------|
| 1 Overview | 5 |
| 2 Preparation | 5 |
| 2.1 Initial Inspection | 6 |
| 2.2 Software Installation | 6 |
| 2.3 Software Requirements | 6 |
| 2.4 Connecting Your Signal Hound | 6 |
| 2.4.1 SM200A/B – SM435B..... | 6 |
| 2.4.2 SM200C and SM435C..... | 7 |
| 2.4.3 <i>⚠Caution – SM200 / SM435 Surfaces May Be Hot</i> | 7 |
| 2.5 Front Panel | 7 |
| 2.5.1 <i>The SM200A/B and SM435B Front Panel</i> | 7 |
| 2.5.2 <i>SM200C and SM435C Front Panel</i> | 8 |
| 2.5.3 <i>GPIO Port</i> | 10 |
| 2.6 Measurement Descriptions..... | 11 |
| 2.6.1 <i>Swept Analysis</i> | 11 |
| 2.6.2 <i>Real-Time Spectrum Analysis</i> | 12 |
| 2.6.3 <i>Zero-Span Analysis and I/Q Streaming</i> | 13 |
| 2.6.4 <i>I/Q Sweep List</i> | 14 |
| 2.6.5 <i>Segmented I/Q Capture (SM200B/SM435B only)</i> | 14 |
| 2.6.6 <i>Internal GPS and Time Stamping</i> | 15 |
| 3 Understanding the SM-series Hardware | 15 |
| 3.1 Highlights | 15 |
| 3.2 Front End Architecture..... | 16 |
| 3.2.1 <i>SM200A/B/C</i> | 16 |
| 3.2.2 <i>SM435B/C</i> | 17 |
| 3.2.3 <i>SM435B Option-80, 800MHz IF Bandwidth Output</i> | 18 |
| 3.2.4 <i>Preselector</i> | 18 |
| 3.3 Signal Processing in the FPGA | 21 |
| 3.4 Residual and Spurious Signals..... | 22 |
| 3.4.1 <i>Residual Signals</i> | 22 |
| 3.4.2 <i>Spurious Signals</i> | 23 |
| 3.5 Scalping Loss | 23 |
| 3.6 Dynamic Range | 24 |
| 3.7 Protecting the RF Input..... | 24 |
| 3.8 Power Management | 24 |
| 3.8.1 <i>Active Cooling</i> | 25 |
| 4 Troubleshooting | 25 |
| 5 Calibration and Adjustment | 26 |
| 6 Functional Specifications | 26 |

| | |
|---|-----------|
| 6.1 Sweep – Normal | 26 |
| 6.2 Sweep – Fast..... | 26 |
| 6.3 Real Time (40MHz – 160MHz span) | 26 |
| 6.4 Real Time (< 40MHz span) | 27 |
| 6.5 Zero Span (IQ Streaming) | 27 |
| 7 SM200 Specifications..... | 27 |
| 8 SM435 Preliminary Specifications | 31 |
| 9 Warranty and Disclaimer | 35 |
| 9.1 Warranty | 35 |
| 9.2 Warranty Service | 35 |
| 9.3 Limitation of Warranty..... | 36 |
| 9.4 Exclusive Remedies | 36 |
| 9.5 Certification..... | 36 |
| 9.6 Credit Notice | 36 |
| 10 Appendix A: Typical Performance..... | 36 |
| 10.1 Sweep Speed (Fast)..... | 36 |
| 10.2 SM200 | 38 |
| 10.2.1 VSWR..... | 38 |
| 10.2.2 Typical IP3..... | 44 |
| 10.3 SM435 | 44 |
| 10.3.1 Typical Phase Noise..... | 44 |
| 10.3.2 Typical DANL (-20 dBm reference level) | 45 |
| 10.3.3 Typical IP2 (at 0 dBm reference level) | 45 |
| 10.3.4 Typical Input IP3 (at 0 dBm reference level) | 46 |
| 10.3.5 Typical LO Leakage..... | 46 |
| 10.3.6 Typical VSWR..... | 47 |
| 10.3.7 Typical Amplitude Accuracy | 47 |

1 Overview

This document outlines the operation and functionality of the SM200A/B/C and SM435B/C Signal Hound spectrum monitor and spectrum analyzer. This document will help you understand the capabilities, performance specifications, and features of your SM200 / SM435.

The SM200/435 is a real-time, high-speed, high dynamic range, low phase noise spectrum analyzer and spectrum monitor, which communicates with your PC over a high speed data link. It has 160 MHz real-time spectrum analysis bandwidth, 40 MHz (USB models) or 160 MHz (10GbE models) real-time streaming I/Q bandwidth, tunes from 100 kHz to 20 GHz, and sweeps 1 THz/s at 30 kHz RBW, internally digitizing and processing 1 billion analog samples per second.

The SM435B has the same features as the SM200B, including the THz/s sweep speed, with the caveat that some spans above 24 GHz may sweep slower than 1 THz/s.

The SM200A can stream up to 40MHz of I/Q bandwidth over USB 3.0.

The SM200B includes 2 GB of internal DDR memory, providing up to 2 seconds of 160 MHz BW segmented I/Q capture read over USB 3.0.

The SM200C and SM435C use a 10 GbE SFP+ interface, and can stream up to 160 MHz I/Q bandwidth.

2 Preparation



2.1 Initial Inspection

Check your package for shipping damage before opening. Your box should contain either a USB 3.0 Vision cable (SM200/435A/B) or a SFP+ module and 3 meter fiber optic cable (SM200/435C), a CD-ROM, a GPS antenna, a 12V power supply, and a Signal Hound SM200/435.

2.2 Software Installation

See the Spike Software manual for installation instructions. You must have administrator privileges to install the software. During the installation of the Spike software, the USB device drivers will also be installed.

2.3 Software Requirements

Supported Operating Systems

- Windows 10/11 (Recommended*)
- Ubuntu Linux 18.04/20.04, 64-bit
- CentOS 7 (API only)

System Requirements

- Processor – 4th generation or newer Intel dual/quad core i-series processors***
 - Quad core 8th generation or newer i7 / i9 recommended for SM200C (200MS/s I/Q streaming)
- 8 GB RAM - 1 GB for the Spike software
- Native USB 3.0 support (SM200A/B and SM435B)†
- 10 GbE SFP+ network interface adapter (SM200C and SM435C)
- OpenGL 3.0 capable graphics processor** (When using the Spike software application)

(* We do not recommend running the SM in a virtual machine (i.e. Parallels/VMWare/etc.))

(** Certain display features are accelerated with this functionality.)

(***Our software is optimized for Intel CPUs. We recommend them exclusively.)

(† Early USB 3.0 controllers from Renesas and ASMedia do not function well with our SM200A/B. Native USB 3.0 hardware is used to refer to Intel's USB 3.0 controllers found on 3rd generation or newer i-series processors.)

2.4 Connecting Your Signal Hound

2.4.1 SM200A/B – SM435B

With the Spike software and USB drivers installed, you are ready to connect your device. For the USB SM devices, plug in the male USB 3.0 into your PC's USB 3 port, and then plug the USB 3.0 Micro-B male connection into the SM device. Your PC may take a few seconds recognizing the

device and installing any last drivers. Wait for this process to complete before launching the Spike software. For the most reliable connection, please use the included USB cable.

2.4.2 SM200C and SM435C

For full setup instructions and network troubleshooting for the SM200C and SM435C, see the network configuration manual.

2.4.3 ⚠ Caution – SM200 / SM435 Surfaces May Be Hot

Depending on operating conditions, ambient temperature, and air flow around the unit, the SM200 or SM435 may be hot to the touch after prolonged use. Use caution when touching the unit.

2.5 Front Panel

2.5.1 The SM200A/B and SM435B Front Panel

The **front panel** has 8 connectors:



1. 9-16V DC power input: Use the included 12V supply, or a battery that can source 40 watts.
2. 50 Ω RF Input: Do not exceed +20 dBm or damage may occur. This will be type N for the SM200 and 2.4 mm for the SM435.
3. SMA GPS antenna port: The GPS antenna (included) may be connected here to discipline the time base and time stamp I/Q data
4. Trigger In: The rising or falling edge of a digital 3.3V or 5V signal may be used to trigger in I/Q streaming modes.
5. 10 MHz out: Use to synchronize external equipment requiring a 10 MHz input. This is also the optional mm-wave IF output port for the SM435.
6. 10 MHz in: Disciplines internal timebase to an external 10 MHz source. 0 to +15 dBm recommended.

7. USB 3 connector with locking screws for Vision cable: Data connection to PC. Both power supply and USB must be connected for device to power on.
8. GPIO port (DB15): Can be used to control external equipment, such as an external antenna switch. Commands may be embedded within a sweep. See [GPIO Port](#) for more information.
9. Status LED: Alternates red/green as commands are processed and sweeps are generated.

2.5.1.1 LED States

The possible SM200A/B LED states are OFF, RED, GREEN, and FLASHING. All combinations of device and LED state are described below.

Initialization States:

OFF – until the power cable and USB cable are both connected.

ORANGE/RED – during device initialization once the power and USB cables are connected.

GREEN – once the device is initialized, the GREEN LED state represents the IDLE state.

Operational States:

ALTERNATING RED/GREEN – when the device is actively transmitting over USB 3.0.

GREEN – Device is idle

RED – Indicates a failure, such as exceeding maximum operating temperature

OFF – Device has lost power

2.5.2 SM200C and SM435C Front Panel

The **front panel** has 9 connectors:



1. 9-16V DC power input: Use the included 12V supply, or a battery that can source 40 watts.
2. 50 Ω type N RF Input: Do not exceed +20 dBm or damage may occur.

3. SMA GPS antenna port: The GPS antenna (included) may be connected here to discipline the time base and time stamp I/Q data
4. Trigger In: The rising or falling edge of a digital 3.3V or 5V signal may be used to trigger in I/Q streaming modes.
5. 10 MHz out: Use to synchronize external equipment requiring a 10 MHz input. This is also the optional mm-wave IF output port for the SM435.
6. 10 MHz in: Disciplines internal timebase to an external 10 MHz source. 0 to +15 dBm recommended.
7. USB 2 connector: Only used for firmware upgrades.
8. SFP+ connector: 10 GbE bi-directional data connection to the PC, using an optical SFP+ module and fiber optic cable.
9. GPIO port (DB15): Can be used to control external equipment, such as an external antenna switch. Commands may be embedded within a sweep. See [GPIO Port](#) for more information.
10. Status LED: Alternates red/green as commands are processed and sweeps are generated.

2.5.2.1 LED States

The possible SM200C LED states are OFF, RED, GREEN, and ALTERNATING. All combinations of device and LED state are described below.

Initialization States:

OFF – until the power cable is connected.

ORANGE/RED – during device initialization once the power is connected.

GREEN – once the device is initialized, the GREEN LED state represents the IDLE state.

Operational States:

ALTERNATING RED/GREEN – when the device is actively transmitting data.

GREEN – Device is idle

RED – Indicates a failure. Usually indicates no 10 GbE connection to PC.

OFF – Device has lost power

2.5.3 GPIO Port

On the front panel of the SM200/SM435 there is a DB15 port which provides up to 8 digital logic lines available for immediate read inputs, or output lines as immediate write pins, or configurable through the API to be able to switch during a sweep based on frequency.

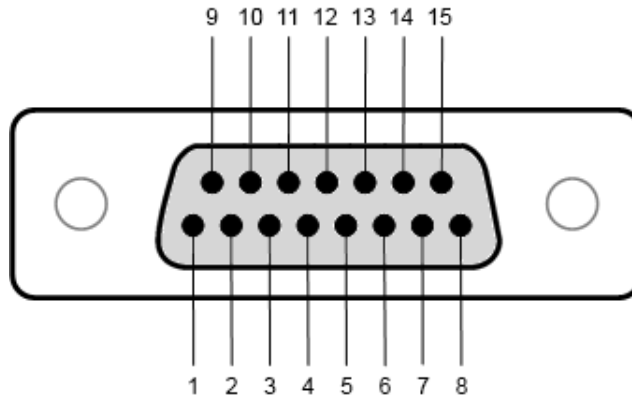

Front panel female DB15 port on SM200

2.5.3.1 Pinout

| | | | |
|----------|----------------------|--------------|----------------------|
| 1 | GPIO(0) | 9 | GPIO(1) |
| 2 | GPIO(2) | 10 | GPIO(3) |
| 3 | Vdd in (1.8 to 3.3V) | 11 | 3.3V out (max 30 mA) |
| 4 | GND | 12 | SPI SCLK |
| 5 | SPI MOSI | 13 | SPI MISO |
| 6 | SPI Select | 14 | GPIO(4) |
| 7 | GPIO(5) | 15 | GPIO(6) |
| 8 | GPIO(7) | Shell | GND |

The GPIO may be configured as 8 outputs, or 4 outputs and 4 inputs, or 8 inputs. The inputs are automatically read at the end of each sweep, but may be read between sweeps as well. The outputs may be written between sweeps, or configured to generate a pattern during each sweep. Any voltage from 1.8V to 3.3V may be applied to pin 3, and the SM200/SM435 will use this voltage for the logic levels. Do not ground pin 3. If pin 3 is left unconnected, the default logic level is 1.6V.

The SPI bus writes at about 5 Mbps, and SPI reads are not currently implemented. The clock idles high, and data transitions on the falling edge of the clock. It can be used to write to most SPI devices where data is latched on the rising edge of the clock.

2.5.3.2 Applications

A typical application for this GPIO port would be to drive an antenna switch. For example, an SP8T switch, such as the Peregrine PE42582, has 3 control lines to select one of 8 antennas, and requires a single 3.3V power supply. A PCB with this switch mounted could be powered from pin 11. Simply connect pins 3 and 11 to select 3.3V logic. GPIO(2) through GPIO(0) could control the switch.

Using the API one could select an antenna, sweep, select a different antenna, and then sweep the same span again.

A more advanced use of this bus would be to actively control and monitor a device under test. For example, a user could test a VCO/PLL by sending a SPI command to the PLL, and routing the SPI select to the trigger in. This would enable the user to make measurements referenced from the rising edge of the SPI select line, to measure PLL settling time, etc.

2.6 Measurement Descriptions

This section details the core measurement and acquisition types for the SM200/SM435 spectrum analyzer.

2.6.1 Swept Analysis

This mode of operation is the mode which is commonly associated with spectrum analyzers. Through the software you will configure the device and request the device perform a single sweep across your desired span. The SM200/SM435 uses fixed local oscillator (LO) frequencies to acquire each 40 MHz patch of spectrum. If the start and stop frequency do not map to the same LO step, multiple 40MHz patches are acquired and concatenated to form the sweep.

The processing performed on each 40MHz patch is determined by the settings provided. A maximum RBW of 3 MHz and a minimum RBW of 0.1 Hz is available in this mode, but low RBWs will be further limited by span. For non-buffered sweeps, each time a trace is returned, the device waits until the next trace request. For buffered sweeps, the next sweep in the queue begins immediately. Users can choose to continuously retrieve traces or manually request them one at a time with the **Single** and **Continuous** buttons found on the **Sweep Toolbar**.

2.6.1.1 RBW/VBW limitations

Low RBW/VBW values increase the working memory footprint of an SM200/SM435 application by increasing the FFT size and increasing buffer sizes for VBW averaging. For 32-bit applications and Spike, this may limit the RBW/VBW in certain configurations.

When utilizing narrow spans (<5MHz) and low RBWs (<3Hz), a significant amount of processing must be done in real-time for the measurement to be valid. Please see our recommended processors if you are having issues with these types of sweeps.

2.6.2 Real-Time Spectrum Analysis

One of the issues with the standard sweep mode is the “blind time” between each trace. Blind time refers to the time between spectrum sampling. During this time, we are processing the last capture, or viewing the data. During this time, it is possible to miss an event. The picture below shows a missed event in green.

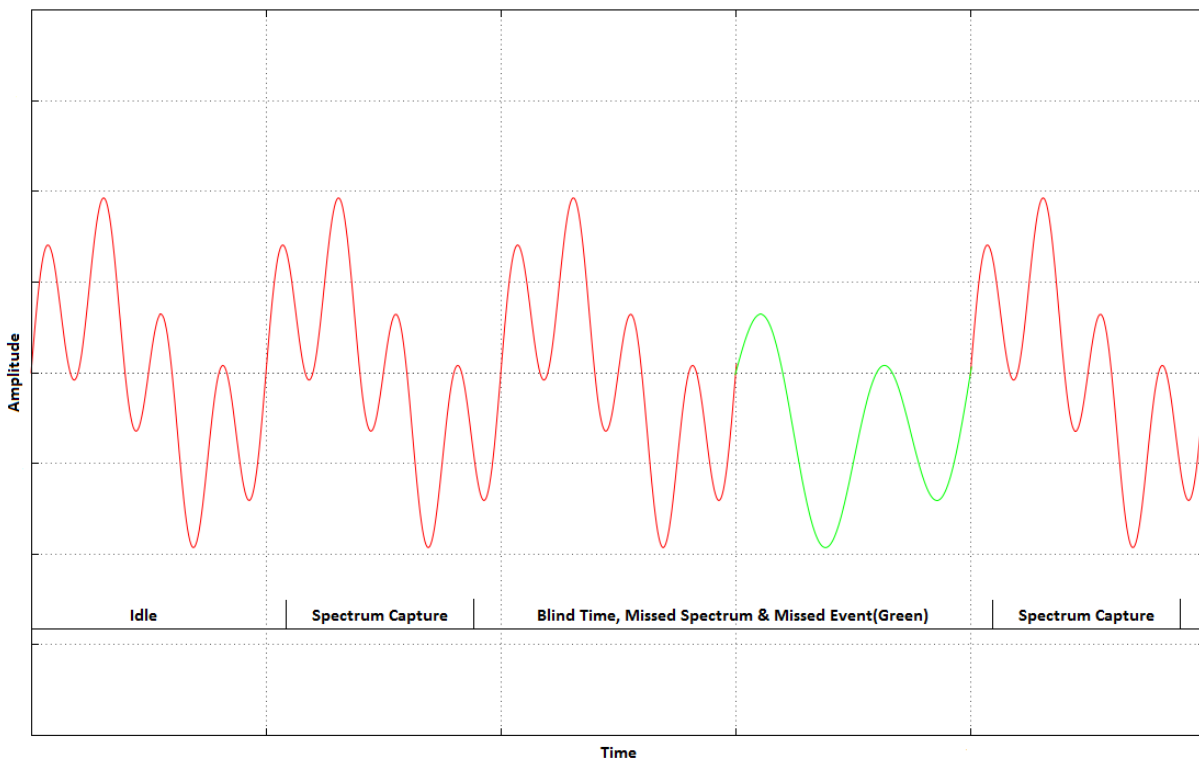

In this image, we see an event missed due to the blind time between spectrum sampling. With Real-Time spectrum analysis we can prevent this and capture ALL events.

For resolution bandwidths (RBW) of 30 kHz or greater, spans of 160 MHz or less, and start frequencies of 650 MHz or greater, the SM200/SM435 can perform real-time spectrum analysis using overlapping FFTs on its Arria 10 FPGA. The FPGA performs overlapping FFTs at an

overlapping rate of 50%, covering each point of data with 2 FFTs. We take the resulting FFTs and min/max or average them into a final returned trace, as well as building a persistence image representing the frequency, amplitude (log scale) points of all FFTs. The number of FFT results merged depends on Real-Time Accumulation and the RBW. Since most of the number crunching happens on the FPGA, a dual core i5 processor would typically be sufficient for this mode.

For spans of 40 MHz or less, the SM200/SM435 is capable of streaming 40 MHz of bandwidth with no time gaps. The PC performs overlapping FFTs at an overlapping rate of 50%, covering each point of data with 2 FFTs. Since the PC can process larger FFTs than the FPGA, more RBWs and additional processing options are available in this mode, such as linear scale persistence plots. Please note that this processing, for spans of 20-40 MHz and low RBWs, typically requires a fast quad core i7 desktop processor. For slower processors, span may need to be reduced or RBW increased for the processor to keep up.

The minimum signal duration to guarantee the same amplitude as a CW signal (i.e. 100% probability of intercept, or POI) in real-time analysis mode is a function of the resolution bandwidth selected, and is equal to 1.5 times the FFT interval. The FFT interval is approximately $2 / \text{RBW}$, so for a 631 kHz RBW, this works out to about 4 microseconds. Lower RBWs will require proportionally longer signal duration. However, signals of even $\frac{1}{4}$ this duration will be displayed only 2-3 dB down.

See the Spike Software manual for further information on Real-time mode.

2.6.2.1 Fast Swept Analysis

When spans wider than 160 MHz must be continuously monitored, the SM200/SM435 can rapidly sweep the selected span by analyzing 160 MHz patches of spectrum using FFTs on the FPGA. This mode is capable of 1 THz/s, and can provide 100% POI for a 2 GHz span of about 2 ms. This mode is used in real-time analysis when span is greater than 160 MHz. In this mode, FFTs occur on the FPGA of the device. This mode has a maximum RBW of 10 MHz and a minimum RBW of 30 kHz. VBW must equal RBW. For more information on typical sweep speed performance see [Sweep Speed \(Fast\)](#).

2.6.3 Zero-Span Analysis and I/Q Streaming

Zero span analysis allows you to view and analyze signals in the time domain using I/Q data acquisitions from the device. The Spike application can display amplitude, frequency, and phase vs. time, and display the results through multiple plots. The SM200A can be configured for up to 50 MS/s, the SM200B/SM435B has an additional 250 MS/s option for captures, and the SM200C and SM435C have additional sample rates of 100 and 200 MS/s available. See the Spike Software manual for further information on using Zero Span analysis.

2.6.3.1 Triggering in Zero Span

You can specify an immediate, video, external, or frequency mask trigger (FMT) in zero-span mode.

Immediate triggering causes the measurement to occur immediately and can be thought of a 'no-trigger'.

Video triggering allow you to begin the measurement only after a signal exceeds a specific amplitude on the RF input. This is useful when you need to analyze a periodic transmission.

External triggering triggers a measurement after a hardware trigger occurs on the trigger SMA port. If your transmitter has a trigger output, you can route this to the trigger in SMA. You can trigger on the rising edge or falling edge of a signal. A 3.3V CMOS trigger with 50 ohm output impedance is ideal, but 5V logic with 50 ohm output impedance is acceptable. Higher or lower output impedance may work with a short BNC cable, but longer cables may cause issues with reflection.

FMT triggering triggers a measurement after a spectrum amplitude exceeds a customer defined spectrum mask. Spectrums are calculated by performing 50% overlapping FFTs on the time domain data.

2.6.4 I/Q Sweep List

I/Q sweep lists allow customers to sweep a list of frequencies and collect a custom number of I/Q samples at each frequency. In this measurement, the SM device can sweep frequencies up to its maximum sweep rate of 120us per frequency (~8333 frequencies per second). Data is sampled at the device's native sample rate, 50MS/s for the USB SM devices, and 200MS/s for the networked SM devices.

Triggering is not available for this measurement. I/Q timestamping is performed at each frequency.

This functionality is only available through the API. See the API manual for more information.

2.6.5 Segmented I/Q Capture (SM200B/SM435B only)

The SM200B and SM435B includes 2 GB of DDR memory for capturing I/Q data at the full 250 MS/s sample rate (160 MHz bandwidth). This memory may be used as a single, contiguous, two second capture, or as multiple smaller (segmented) captures. Trigger modes for these captures include video, external, and frequency mask triggers (FMT). A user-specified pre-trigger capture length enables the capture of I/Q data both before and after the trigger event. After the I/Q data is captured, it is transferred to the PC at approximately 200 MB/s. This new function is available

through the application programming interface (API). See the API manual for more information. The Spike software also includes this new 250 MSPS sample rate for short captures in Zero Span mode.

Please note that the video trigger in this mode is happening in the FPGA on partially filtered data. An additional FIR filter on the PC will attenuate out-of-band signals and noise that may have contributed to the video trigger event.

2.6.6 Internal GPS and Time Stamping

The internal GPS, when the antenna is connected and GPS signal is present, synchronizes the OCXO to typically within a part per billion after about 10 minutes. The pulse-per-second (PPS) signal also generates an automatic internal trigger that is used to time stamp I/Q data in all I/Q acquisition modes.

3 Understanding the SM-series Hardware

3.1 Highlights

All SM series analyzers use an ultra-low phase noise 100 MHz OCXO, which is multiplied and filtered to generate a clean 1 GHz reference. The Local oscillator (LO) uses this 1 GHz reference in a translation loop architecture, providing very low close-in phase noise with considerably lower spurious than a DDS.

The SM series has been designed to have high IP3 and low DANL at all input levels, giving users the ability to monitor the spectrum at full sensitivity without worrying about overdriving the front end or generating excessive intermodulation products.

The hardware completely reconfigures the LO, RF, and FIR correction filters in under 20 microseconds, with a minimum frequency step time of 120 microseconds. The remaining 100 microseconds, when used to collect and process a 160 MHz patch of spectrum, provide a 2 GHz sweep in under 2 ms, or over 1 THz/sec.

Continuous THz/s sweep rates enable the analyzer to monitor spans larger than 160 MHz, hundreds or thousands of times per second. For example, using a 30 kHz RBW, a user can sweep 700 MHz to 2700 MHz, 500 times per second.

3.2 Front End Architecture

3.2.1 SM200A/B/C

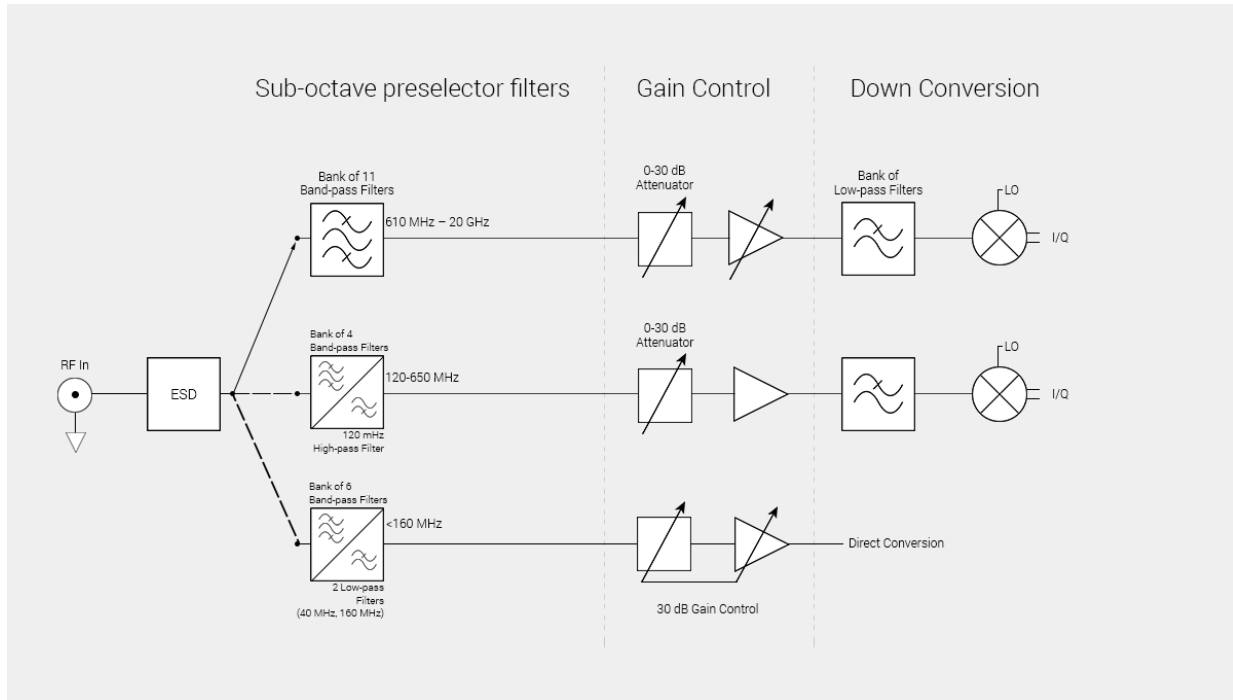

The SM200 is a low IF receiver. We chose this architecture to complement our low phase noise local oscillator (LO), while avoiding the shortfalls of zero IF (direct) conversion, and because of the availability of high linearity direct conversion demodulators and I/Q mixers.

The SM200 contains four mixer bands covering 120 MHz to 20 GHz, and one direct conversion band covering 100 kHz to 160 MHz. A preselector, consisting of 21 sub-octave band pass filters, covers 20 MHz to 20 GHz. Below 650 MHz, the preselector may be bypassed to increase sweep speed and improve phase response (shown as high pass and low pass filters rather than band pass filters), and guarantee 40 MHz of useable bandwidth. With the preselector enabled, as little as 6 MHz of I/Q data may be available, especially below 100 MHz center frequency.

Four separate mixers, optimized for IP3 and image rejection within their operating range, convert the incoming RF signal into baseband I/Q signals. In the SM200, the LO is typically injected above the RF by 15-180 MHz. This generates a baseband I/Q signal, which is filtered and then digitized at 500 MSPS, and streamed to Intel's Arria 10 FPGA.

3.2.2 SM435B/C

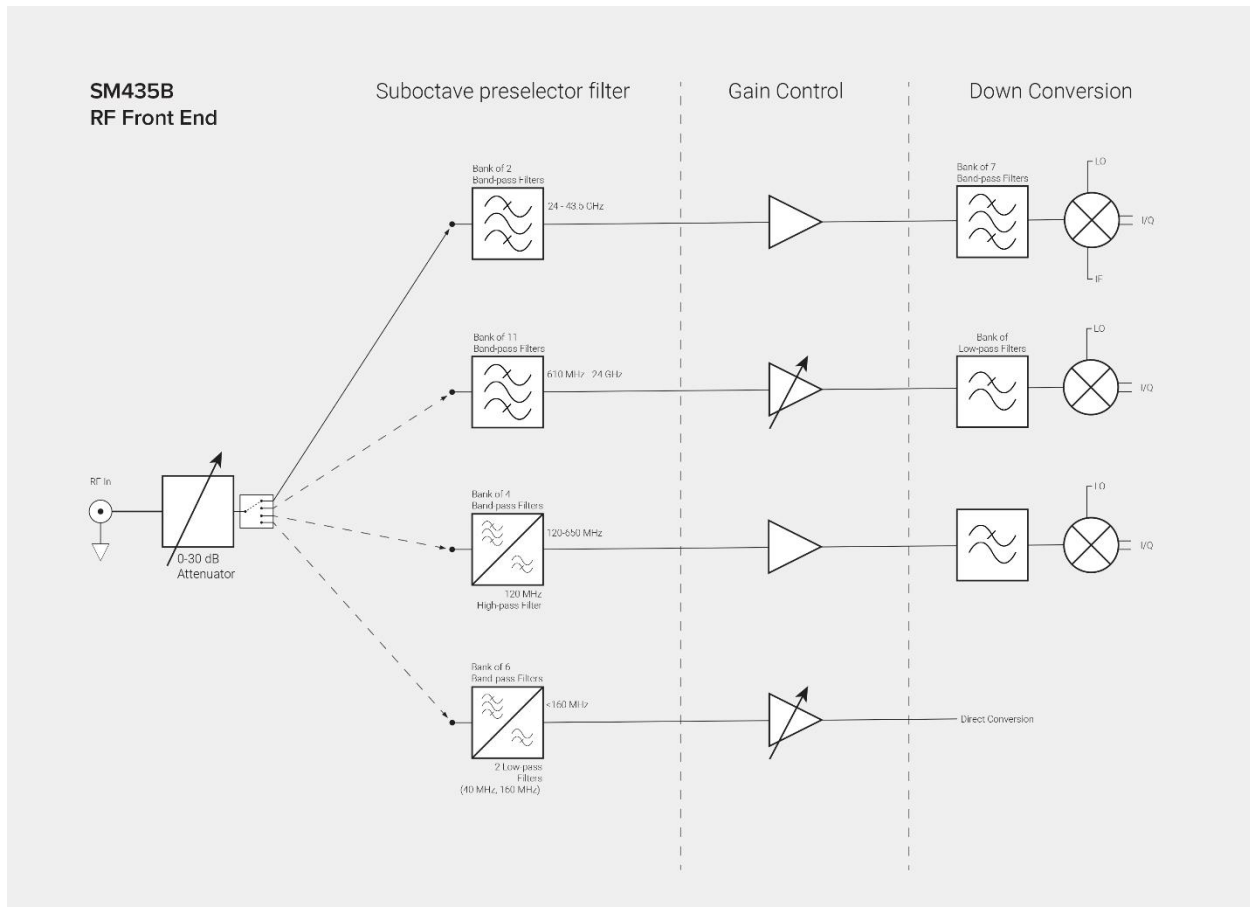

The SM435 uses the same low IF architecture as the SM200, extended to 43.5 GHz. The LO translation loop has been improved to reduce spurious even further, and LO and RF filtering have been added to improve spurs from LO sub-harmonics.

The SM435 contains five mixer bands covering 120 MHz to 43.5 GHz, and one direct conversion band covering 100 kHz to 160 MHz. A preselector, consisting of 23 sub-octave band pass filters, covers 20 MHz to 43.5 GHz. Sub-harmonic responses from 8-24 GHz are reduced using sub-octave filters for both LO and RF. From 24-43.5 GHz, sub-harmonic responses are reduced with a bank of 7 RF filters.

The millimeter-wave downconverter in the SM435 has both IF and I/Q outputs. In the standard unit, for frequencies below 41 GHz the I/Q output is digitized, and for frequencies above 41 GHz, a 3 GHz IF output is downconverted and digitized. For units with the IF output option, the SM435 may be used as a low phase noise millimeter-wave downconverter. Instead of downconverting and digitizing the IF, it is output to the front panel. This IF output is centered at 1.5 GHz, has >800 MHz 3-dB bandwidth, and may be used from 24 to 43.5 GHz. The IF output option limits the

maximum RF frequency it can digitize and send to the PC to 40.8 GHz. The LO is injected low side so the spectrum is not inverted. The amplitude of the IF output can be adjusted with the attenuator setting in Spike’s IF Output control. A IF output power of around -20 dBm should have adequate dynamic range for most measurements.

3.2.3 SM435B Option-80, 800MHz IF Bandwidth Output

800MHz of IF bandwidth is available for the SM435 as option-80. This option replaces the front panel 10MHz output with a 1.5GHz IF output having 800MHz of bandwidth. This option makes 24GHz to 43.5GHz available for a front panel IF down conversion output with 800MHz of bandwidth and eliminates standard internal processing above 40.8GHz. The 40.8GHz to 43.5GHz band is available only as an 800MHz bandwidth of down converted IF output when this option is installed. The local oscillator (LO) is injected low side, so there is no spectral inversion.

RF Attenuator Setting 0 to 30 dB in 5 dB steps

RF Input Frequency 24 GHz to 43.5 GHz

IF Output Frequency 1.5 GHz center

3 dB Bandwidth > 800 MHz Typical

Typical Performance (0 dB attenuation)

| Frequency (GHz) | Gain, dB (center) | 3 dB bandwidth | Image rejection BW (>40 dB) |
|-----------------|-------------------|-------------------|-----------------------------|
| 28 | 5.0 | 600 MHz – 2.1 GHz | 1.09 – 2.10 GHz |
| 38 | 4.1 | 600 MHz – 2.1 GHz | 1.01 – 2.10 GHz |

Note: Gain rolls off above 40 GHz to around -4 dB at 43.5 GHz. The IF output is adjusted only for image rejection, and each SM435 will have a slightly different gain curve.

3.2.4 Preselector

The preselector is a collection of sub-octave filters spanning 20 MHz to 20 GHz / 43.5 GHz. It removes out-of-band energy from the RF input before any amplification or mixing occurs. The low frequency preselector filters may be bypassed to increase sweep speed and increase available bandwidth at low frequencies, at the expense of IP2.

In sweep mode, the insertion loss of the optional preselector filters is compensated for by the API, but when I/Q streaming below 645 MHz with the preselector on, only an average amplitude correction is applied. This will increase the typical amplitude error observed at the filter edges by a small amount (typically 0.5 dB). In spectrum analysis modes, this error is removed and full

amplitude accuracy is maintained. A minimum overlap of 6 MHz ensures commonly used VHF signals can be streamed even with preselector on.

When the optional preselector filters are bypassed, the full 40 MHz of I/Q streaming is available at all frequencies. However, below 645 MHz, the 160 MHz hardware real-time is not available.

Below 650 MHz, all the preselectors have a shape similar to the one shown (filter 7):

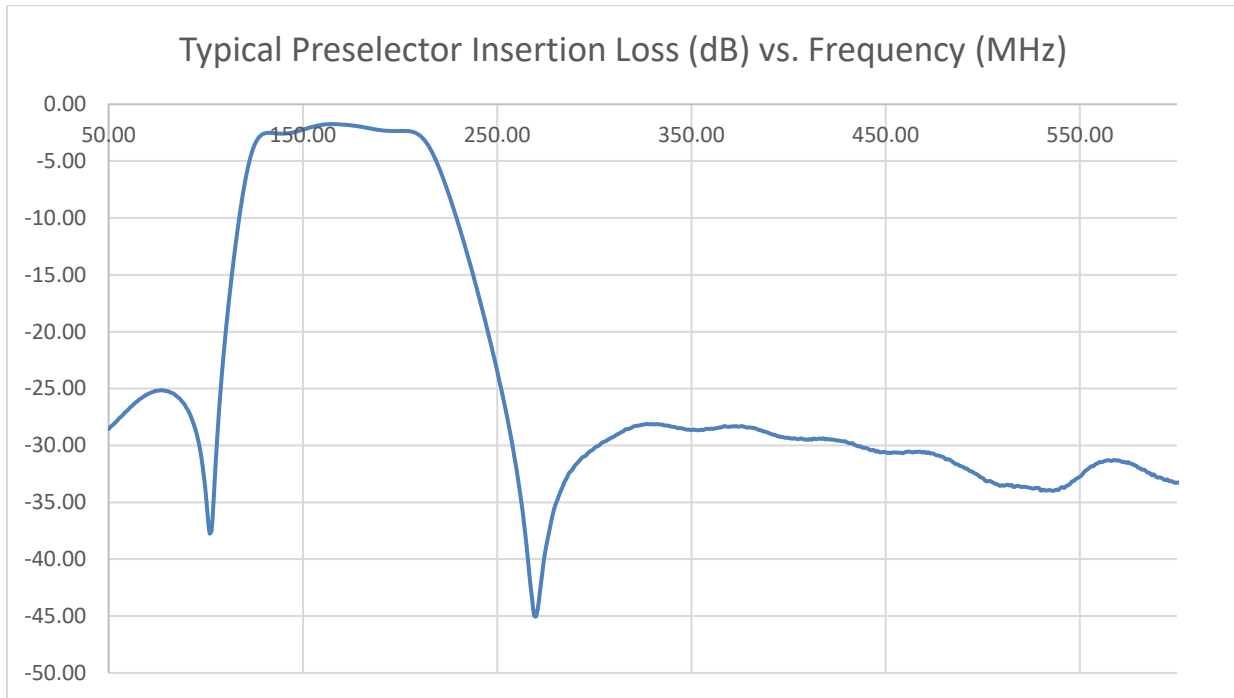

When using optional preselector filters with I/Q streaming, or when predicting if a preselector will help block an interfering signal, use the following tables.

Optional Preselector Filters

| Filter | Range used for Sweeps (MHz) | Useable Range for I/Q streaming | Bypass Filter (Preselector Off) |
|---------|-----------------------------|---------------------------------|---------------------------------|
| 0 (LPF) | 0-19.5 | 0-40 | 160 MHz LPF |
| 1 | 19.5-29.3 | 19-31 | 160 MHz LPF |
| 2 | 27-36 | 23.8-39 | 160 MHz LPF |
| 3 | 36-47 | 33-52 | 160 MHz LPF |
| 4 | 47-63 | 42-68 | 160 MHz LPF |
| 5 | 63-92 | 59-100 | 160 MHz LPF |
| 6 | 92-136.7 | 86-146 | 160 MHz LPF |
| 7 | 136.7-198 | 130-210 | 110 MHz HPF |
| 8 | 198-293 | 190-303 | 110 MHz HPF |
| 9 | 293-410 | 280-440 | 110 MHz HPF |
| 10 | 410-644.5 | 400-645 | 110 MHz HPF |

Always-On Preselector Filters (SM200)

| Filter | Frequency Range used for Sweeps |
|--------|---------------------------------|
| 11 | 644.5 - 957 MHz |
| 12 | 957 - 1465 |
| 13 | 1465-1855 |
| 14 | 1855 - 2400 |
| 15 | 2400 - 3260 |
| 16 | 3260 - 4460 |
| 17 | 4460 - 6150 |
| 18 | 6150 - 8180 |
| 19 | 8180 - 10960 |
| 20 | 10960 - 14000 |
| 21 | 14000 - 20000 |

Always-On Preselector Filters (SM435)

| Filter | Frequency Range used for Sweeps |
|--------|--|
| 11 | 644.5 - 957 MHz |
| 12 | 957 - 1390 |
| 13 | 1390-1820 |
| 14 | 1820 - 2400 |
| 15 | 2400 - 3260 |
| 16 | 3260 - 4460 |
| 17 | 4460 - 6150 |
| 18 | 6150 - 8200 |
| 19 | 8200 - 12300 |
| 20 | 12300 - 16000 |
| 21 | 16000 - 24000 |
| 22 | 24000 – 34500 post-amp filters 24-27, 27-29.25, 29.25-31.25, 31.25-34.5 GHz |
| 23 | 34500 – 43500 post-amp filters 34.5-37.25, 37.25-39.85, 39.85-43.5 GHz |

3.3 Signal Processing in the FPGA

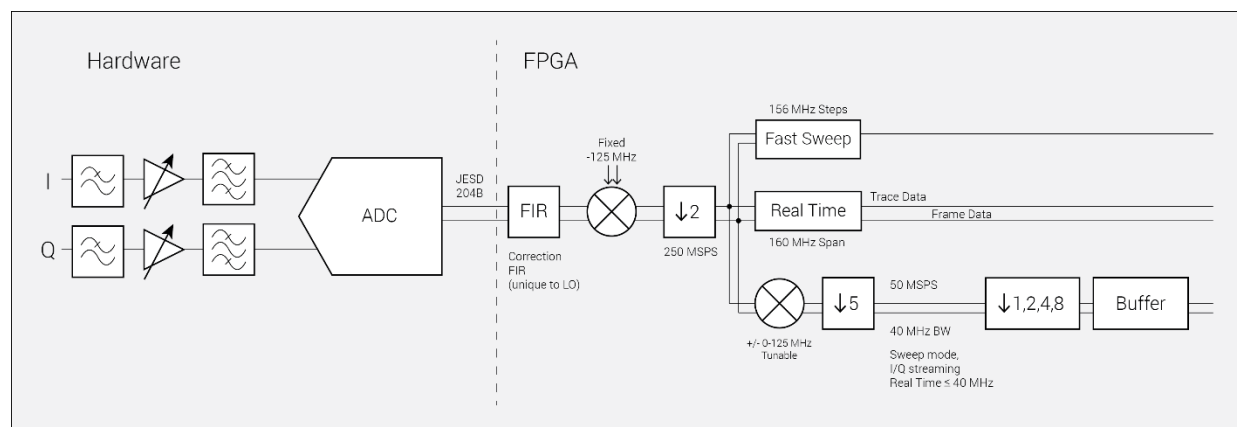

The digitized data is processed with a special FIR filter to reject the image response and flatten the frequency response. This data is then digitally tuned to select the lower sideband, decimated down to 250 MSPS I/Q, and distributed to several signal processing blocks within the FPGA.

The Fast Sweep processing block takes a short burst of 250 MSPS I/Q data, does an FFT, converts to dB, and stores the result with 0.01 dB resolution into a 16-bit register. This, combined with a fast-switching LO, enables THz/sec sweep speeds with a 30 kHz RBW.

The Real-Time processing block takes a continuous stream of 250 MSPS I/Q data and does 50% overlapping FFTs. For the real-time frame buffer, the results of these FFTs are converted to dB, and plotted on a two-dimensional image showing how many times that frequency was at that amplitude during the real-time frame interval. The offset and scaling, from dB to pixels, is controlled by your reference level and dB/div.

For the real-time trace buffer, either min/max or average is selected. In the case of average, the results of the FFT is converted to power and summed. When min/max is selected, the FFT is converted to 0.01 dB resolution, and processed through a min hold and max hold trace buffer.

The SM200B and SM435B include a 2 GB DDR capture buffer at the 250 MSPS I/Q rate.

The SM200A/B and SM435B I/Q Streaming processing block first tunes the 250 MSPS I/Q data to a new center frequency, and then decimates by 5, to provide 50 MSPS I/Q data with 40 MHz useable bandwidth. There are additional decimate-by-2 stages to further decimate the data to 25, 12.5 or 6.25 MSPS if desired. This can significantly reduce the PC's processing requirements for smaller bandwidth signals. For LTE applications, the hardware can also resample to 61.44, 30.72, 15.36, and 7.68 MHz.

The SM200C and SM435C I/Q streaming processing block first tunes the 250 MSPS I/Q data to a new center frequency, and then resamples by 4/5, to provide 200 MSPS I/Q data with 160 MHz useable bandwidth. There are additional decimate-by-2 stages to further decimate the data to 100, 50 or 25 MSPS if desired. This can significantly reduce the PC's processing requirements for smaller bandwidth signals. For LTE applications, the hardware can also resample to 122.88, 61.44, 30.72, and 15.36 MHz.

I/Q sample rates of 50 MS/s or lower are fully corrected. Sample rates above 50 MS/s, especially when using frequencies below 700 MHz, may use interpolated or extended correction data, and are not fully calibrated. For these high sample rates, specified accuracy is typically maintained, but is not guaranteed.

3.4 Residual and Spurious Signals

3.4.1 Residual Signals

A residual signal appears even when there is no signal input. The SM200 has some low level residual signals, especially above 10 GHz. The SM435 does as well, but typically below the noise floor in most cases.

3.4.2 Spurious Signals

Typically, the spur with the highest amplitude will be the image response, located 40-120 MHz below the actual RF signal. This will typically be around -63 dBc below 6 GHz, -57 dBc above 6 GHz.

Spurious signals also arise from spectral impurities in the LO, as well as undesired mixing products. The translation loop architecture tends to have low level spurs around 30-60 MHz from the carrier. These will have minimal impact when measuring signals of 25 MHz bandwidth or less. There may be spurs inside of 30 MHz at some frequencies. Undesired mixing products typically show up at multiples of $(LO - RF)$.

Another source of spurious is subharmonics of the LO, above 6 GHz for the SM200 and above 8 GHz for the SM435. For most frequencies, these will be too low to interfere with typical measurements, and are several GHz away from the signal of interest.

3.5 Scalping Loss

An FFT-based spectrum analyzer uses digital resolution bandwidths rather than discrete analog filters. Moving from analog to digital introduces some new terms important to measurement accuracy, like FFT bins, window functions, spectral leakage and scalping loss. To sum up, an FFT produces an array of discrete frequency bins and their associated amplitude. Real-world signals rarely line up exactly with a single frequency bin, which can result in some ugly behavior unless a window function is used. Many different window functions are available, with various strengths and weaknesses.

For the SM200, swept modes default to a flat top window, which offers excellent amplitude flatness and therefore very little scalping loss, in exchange for a wider resolution bandwidth and longer processing time. Most RBWs used by the SM200 are from flat top windows, so scalping loss is negligible.

In real-time mode a Nuttall window function is often used, which has a narrower bandwidth to reduce processing time and level out impulse response. However, when a signal falls halfway between two “bins,” the energy is split between adjacent bins such that the reported “peak” amplitude may be lower by as much as 0.8 dB.

To get an accurate CW reading using “Marker peak”, flat top RBW shape in swept mode is recommended.

In either mode, the “channel power” utility, which integrates the power across any channel bandwidth you specify, also eliminates this scalping loss, giving you a full accuracy amplitude reading even in real-time mode.

3.6 Dynamic Range

Dynamic range has many definitions, but one common definition in spectrum analysis is $2/3(\text{TOI} - \text{DANL})$. A typical number for 1 GHz, -10 dBm reference level (10 dB attenuator), would be: $\text{TOI} = +21 \text{ dBm}$, $\text{DANL} = -150 \text{ dBm}$ (1 Hz RBW). Dynamic range, $2/3 (\text{TOI} - \text{DANL}) = 114 \text{ dB}$, and would be mostly a function of RBW and frequency.

3.7 Protecting the RF Input

The SM200 and SM435 front end have a DC block rated to 16 VDC and ESD protection, but ESD damage is still possible. Signals above +20 dBm peak (not RMS) can also cause damage. Some common events which may lead to front end damage include:

- 1) Applying more than +20 dBm peak power, such as an antenna exposed to a radar pulse.
- 2) ESD from a passive antenna, either from discharge to an antenna element, or from connecting a large antenna or cable which has built up a static charge.

For any application which may expose the SM200 to front end damage, including connecting to active or passive antennas, a coaxial limiter is recommended to protect the input.

A limiter will protect against overpowering the input, typically raising the damage level above 2 watts, as well as offering additional protection against ESD. It will also offer some protection against the energy spike you get when connecting to equipment with a DC or static voltage present. The energy may significantly exceed +20 dBm for several microseconds.

Generally, the performance at low input signal levels is just the insertion loss of the limiter, but at high signal levels there will be some nonlinearity and the resulting intermodulation products. A typical limiter will have an IP3 around +30 dBm, so for input signals below -20 dBm there should be little to no effect on SM200 linearity.

If it is a passive antenna mounted using a long coaxial cable, it may be building up a significant static charge until it is connected. For this reason, it might make the most sense to keep the limiter connected to the antenna rather than the SM200 / SM435. A DC block is probably not necessary for passive antennas in most cases.

3.8 Power Management



Caution: *After the SM200 or SM435 has been running for a while, it may be hot!*

The SM200, when running full tilt, typically consumes 25-30 watts of power, and the SM435 uses 28-34 watts typically. This can lead to two problems:

1. Battery-powered applications have high drain rates
2. The heat generated causes unit to overheat and shut down in hot climates.

To reduce this, a reduced power state is available when needed. This state reduces SM200 power consumption to 12-14 watts and SM435 power consumption to 22 watts, and requires about 30 ms to resume operations. Using the reduced power state will reduce power consumption, and although it can resume sweeping or streaming within 30 ms, it takes a full second for the SM200 amplitude and phase noise to fully stabilize after exiting this state. Typically, about 0.7 dB amplitude variations, and several dB of extra phase noise are observed in this state. In the Spike software, this feature can be activated by increasing your **Sweep Interval**. If you only need to sweep once per second, power consumption may be cut in half typically.

Some remote applications may require hours or days of off time in between uses, where battery life is at a premium. By remotely shutting off a PC or laptop equipped with vPro or similar technology, the USB voltage will drop to 0V, the SM200 will sense this and fully power down.

The FPGA in the SM200 has a maximum operating core temperature of 100 °C. Exceeding this will cause the SM200 to automatically power down the RF, LO, and system clocks. The software must close and re-open the device after it has sufficiently cooled to resume operations.

When using the 110/220V wall adapter, power interruptions and large surges may cause the device to lose connection to the PC. Operation can be restored by reconnecting manually or automatically, but several seconds of data acquisition may be lost. Depending on application and location, consider using battery power or a surge-protected uninterruptible power supply (UPS).

3.8.1 Active Cooling

An optional active cooling module may optionally be installed. Forced air reduces the temperature difference between the SM200/SM435 and ambient air temperature. The fan will be turned on when the device is warm, and off when the device is cool. Vibration from the fans may affect phase noise, so the fan may be turned off during phase noise measurements.

4 Troubleshooting

Troubleshooting information can be found in the Spike user manual and the network configuration manual for troubleshooting 10GbE networking issues.

5 Calibration and Adjustment

Calibration and adjustment of the SM200/SM435 can be performed by Signal Hound. Additionally, calibration software is freely available for customer on-site calibration, but requires specialized equipment typically found only in calibration labs. The calibration software provided can perform timebase adjustments only. If other adjustments are required, the analyzer must be returned to Signal Hound.

Contact Signal Hound for more information regarding calibration software and required equipment, or to schedule a calibration.

6 Functional Specifications

6.1 Sweep – Normal

| | |
|------------------------|--|
| IBW | 40MHz |
| Frequency range | 100kHz to 20GHz / 43.5GHz |
| RBW range | 0.1Hz to 3MHz |
| RBW / VBW ratio | 1 to 1000, selectable/arbitrary |
| Sweep speed | 160 GHz/sec @ 10 kHz RBW 18 GHz/sec @ 1 kHz RBW |

6.2 Sweep – Fast

In Spike, fast sweep measurement mode is active when real-time measurement mode is selected with a span greater than 160MHz.

| | |
|------------------------|----------------------------|
| IBW | 160MHz |
| Frequency Range | 100kHz to 20GHz / 43.5GHz* |
| RBW Range | 30kHz to 10MHz |
| VBW Ratio | 1 (VBW not selectable) |
| Sweep Speed | 1THz/s |

*Below 650MHz center frequency, the sweep speed drops below 1THz/s due to the smaller IF bandwidth available at lower frequencies. Above 24 GHz, the sweep speed drops below 1 THz/s for certain spans due to hardware settling time.

6.3 Real Time (40MHz – 160MHz span)

| | |
|------------------------|---------------------------|
| IBW | 160MHz |
| Frequency Range | 700MHz to 20GHz / 43.5GHz |
| RBW Range | 30kHz to 10MHz |

SM200 Specifications | Real Time (< 40MHz span)

VBW Ratio 1 (VBW not selectable)

6.4 Real Time (< 40MHz span)

IBW 40MHz
Frequency Range 100kHz to 20GHz / 43.5GHz
RBW Range 1.5kHz to 800kHz
VBW Ratio 1 (VBW not selectable)

6.5 Zero Span (IQ Streaming)

IBW 40MHz (all models, all frequencies)
160 MHz (SM200B/C above 650 MHz)
Frequency Range 100kHz to 20GHz / 43.5GHz
Sample Rate 12.2kS/s to 50MS/s (all models)
(Base 50MS/s decimated by powers of two up to 4096)
250 MS/s (SM200B / SM435B)
100 MS/s, 200 MS/s (SM200C / SM435C)
BW Selectable, arbitrary.
(Sample rate * 0.8) maximum bandwidth.

7 SM200 Specifications

The following specifications are based on a set of operating conditions, which are the power-up default settings, unless otherwise stated: 1) Operating in the Preset condition, 2) Using internal timebase, 3) Video processing set for average and power, 4) VBW, sweep, gain, and attenuation in the default auto mode, 5) Optional preselectors bypassed. 6) Ambient room temperature (18 - 28C)

IP2 and IP3 testing is performed at a -10 dBm reference level with preselector on, and normalized to a 0 dBm reference level, which is the functional equivalent of 0 dB RF gain, or the “preamplifier off” setting of a typical receiver. At maximum sensitivity (-20 dBm reference level), IP2 and IP3 will typically be 20 dB lower.

DANL is tested at maximum sensitivity (-20 dBm reference level)

Frequency Range 100kHz to 20GHz
RF Input Impedance (type-N connector) 50Ω Nominal
⁴Calibrated Streaming I/Q 5kHz to 40MHz of selectable I/Q bandwidth.

SM200 Specifications | Zero Span (IQ Streaming)

| | |
|--------------------------------------|---|
| Resolution Bandwidths (RBW) | 0.1 Hz (≤ 200 kHz span) to 3MHz (any span) using the 40MHz IBW 30kHz to 10MHz using the 160MHz IBW |
| Timebase Accuracy | GPS disciplined OCXO remains within $\pm 5 \times 10^{-10}$ when locked to GPS; Holdover of $\pm 5 \times 10^{-9}$ per day for aging ($\pm 2 \times 10^{-8}$ first day typical) Holdover of $\pm 1 \times 10^{-8}$ for temperature over -40°C to 65°C typical |
| System Noise Figure (typical) | 11dB from 700MHz to 2.7GHz 14dB from 2.7GHz to 4.5GHz 18dB from 4.5GHz to 15GHz |
| IP₂ | +64dBm from 100kHz to 2GHz +74dBm from 2GHz to 11GHz +76dbm from 11GHz to 15GHz +60dBm from 15GHz to 20GHz |
| IP₃ | +28dBm 100kHz to 4GHz +23dBm 4GHz to 6GHz +18dBm 6GHz to 14GHz +23dBm 14GHz to 20GHz |

Sweep Speed (using Nuttall windowing)

| Sweep Speed | 1 THz/sec | 1THz/sec | 1THz/sec | 160GHz/sec | 18GHz/sec |
|-------------|-----------|----------|----------|------------|-----------|
| RBW | 1MHz | 100kHz | 30kHz | 10kHz | 1kHz |

Amplitude Accuracy (+10dBm to Displayed Average Noise Level (DANL))

| 100kHz to 6GHz | >6GHz to 20GHz | RBW filter shape |
|----------------|----------------|--------------------|
| ± 2.0 dB | ± 3.0 dB | Flat-Top windowing |
| +2.0dB/-2.6dB | +3.0/-3.6dB | Nuttall windowing |

⁵Displayed Average Noise Level (DANL)

| Input Frequency Range | dBm/Hz |
|-----------------------|----------|
| 100 kHz to 700 MHz | -156 dBm |
| 700 MHz to 2.7 GHz | -160 dBm |
| 2.7 GHz to 4.5 GHz | -158 dBm |
| 4.5 GHz to 8.5 GHz | -153 dBm |
| 8.5 GHz to 15 GHz | -154 dBm |
| 15 GHz to 20 GHz | -149 dBm |

LO Leakage at RF Input

-82dBm from 100kHz to 5GHz
 -55dBm from 5GHz to 10GHz
 -50dBm from 10GHz to 18GHz
 -47dBm from 18GHz to 20GHz

⁵Residual Responses (Ref Level \leq -20dBm, 0dB Attenuation, 50-ohm load on RF input)

| Input Frequency Range | Residual Level (dBm) |
|-----------------------|----------------------|
| 100kHz to 80 MHz | -110 |
| 80 MHz to 15 GHz | -100 |
| 15 GHz to 20GHz | -90 |

⁵Spurious Responses (any ref level (RL) from +10dBm to -20dBm, in 5dB increments, input 10dB < RL, RBW \leq 30kHz, 40MHz IBW)

| Input Freq. Range | Image Reject Off (dBc) | Image Reject On (dBc) typical |
|-------------------|------------------------|-------------------------------|
| 100 kHz to 6 GHz | -58 | -75 |
| 6 GHz to 10 GHz | -55 | -75 |
| 10 GHz to 20 GHz | -44 | -75 |

Sub-Octave Filtered Preselector

20MHz to 20GHz

⁵SSB Phase Noise at 1GHz Center Frequency

| Offset Frequency | dBc/Hz |
|------------------|--------|
| 10Hz | -76 |
| 100Hz | -108 |
| 1 kHz | -123 |
| 10kHz | -132 |
| 100kHz | -136 |
| 1 MHz | -133 |

| | |
|--|--|
| Synchronization | GPS data in each packet with ± 40 ns time-stamping |
| FPGA | Altera 10AX027 has 1660 multipliers, provides selectable decimation, 160MHz of instantaneous bandwidth from FFT processing, and has resources to spare for future growth |
| Connectivity | ⁴ Local external computer with Microsoft Windows or Ubuntu Linux and one USB3.0 port is required to operate the SM200A/B (minimum of Intel 3 rd Gen i7 processor or equivalent). For the SM200C, a PC / laptop with a 10 GbE SFP+ interface is required, and a minimum of a quad core 6 th Gen i7 is recommended. |
| GPIO Port | Used for antenna switching and in/out triggering |
| GUI Languages | English, Simplified Chinese, Dutch, French, German, Italian, Japanese, Russian, and Spanish |
| ⁸Operating Temperature (ambient) | <u>Standard:</u> 32°F to 122°F (0°C to +50°C) passive cooling <u>Option 1:</u> -40°F to 149°F (-40°C to +65°C) active cooling & extended temperature |
| ⁶Size | 10.2" x 7.2" x 2.15" (259mm x 183mm x 55mm) passive cooling 10.2" x 7.2" x 2.74" (259mm x 183mm x 70mm) active cooling |
| Weight | 7.94 lbs. (3.60 kg) passive cooling (Standard) 8.98 lbs. (4.07 kg) active cooling (Option 1) |
| Power Consumption | 17 watts (when idling) or 32 watts (when sweeping or streaming I/Q) sourced from the AC wall adapter which is included or from an external supply of 9V to 16V when using the Option-12 LEMO Pigtail. |

¹Dynamic Range is defined here as $\frac{2}{3}$ of the difference between IP_3 and DANL as measured in ITU-R SM.1837, normalized to dB/Hz

SM435 Preliminary Specifications | Zero Span (IQ Streaming)

²For EVM measurements of signals having symbol rates between 100 kHz and 1MHz. The SM200A/B will contribute a somewhat higher EVM error for symbol rates outside of this range.

⁴Streaming I/Q and burst I/Q are bandwidth limited to the speed of the available Ethernet connection.

⁵DANL, Residual Responses, Spurious Mixer Responses, and Phase Noise specifications are production tested and guaranteed only at 23°C ($\pm 5^\circ\text{C}$). Typical performance of these characteristics, over the instrument's operating temperature range, will be published as graphs in the User's Manual.

⁶The SM200 length is 10.97" (0.77" longer) when counting the front panel type-N RF input connector and 0.375" higher when counting feet.

8 SM435 Preliminary Specifications

The following specifications are based on a set of operating conditions, which are the power-up default settings, unless otherwise stated: 1) Operating in the Preset condition, 2) Using internal timebase, 3) Video processing set for average and power, 4) VBW, sweep, gain, and attenuation in the default auto mode, 5) Optional preselectors bypassed. 6) Ambient room temperature (18 - 28C)

IP2 and IP3 testing is performed at a -10 dBm reference level with preselector on, and normalized to a 0 dBm reference level, which is the functional equivalent of 0 dB RF gain, or the "preamplifier off" setting of a typical receiver. At maximum sensitivity (-20 dBm reference level), IP2 and IP3 will typically be 20 dB lower.

DANL is tested at maximum sensitivity (-20 dBm reference level)

| | |
|---|---|
| Frequency Range | 100kHz to 43.5GHz 100 kHz to 40.8 GHz (mm-wave IF output option) |
| RF Input Impedance (2.4mm connector) | 50 Ω Nominal |
| RF Input VSWR | <1.45 50 MHz to 10 GHz <1.7 10 GHz to 20 GHz <2.0 20 GHz to 43.5 GHz |
| ⁴Calibrated Streaming I/Q | 5kHz to 40MHz of selectable I/Q bandwidth. (SM435B) Up to 160 MHz (SM435C) |
| Resolution Bandwidths (RBW) | 0.1 Hz ($\leq 200\text{kHz}$ span) to 3MHz (any span) using the 40MHz IBW 30kHz to 10MHz using the 160MHz IBW |
| Timebase Accuracy | GPS disciplined OCXO remains within $\pm 5 \times 10^{-10}$ when locked to GPS; Holdover of $\pm 5 \times 10^{-9}$ per day for aging |

SM435 Preliminary Specifications | Zero Span (IQ Streaming)

($\pm 2 \times 10^{-8}$ first day typical)

Holdover of $\pm 1 \times 10^{-8}$ for temperature over -40°C to 65°C typical

System Noise Figure (typical)

12dB from 700MHz to 2.5GHz
 15dB from 2.5GHz to 24GHz
 18dB + 0.5 dB/GHz from 24GHz to 40GHz
 26 dB + 2 dB/GHz above 40 GHz

IP₂

+75dBm from 100kHz to 20GHz
 +50dBm from 20GHz to 24GHz
 (s/n 22104xxx and 22227xxx only)
 +70 dBm from 20GHz to 24GHz
 (all other serial numbers)
 +70dBm from 24GHz to 43.5GHz

IP₃

+28dBm 100kHz to 4GHz
 +23dBm 4GHz to 6GHz
 +20dBm 6GHz to 43.5GHz

Sweep Speed (using Nuttall windowing)

| Sweep Speed | 1 THz/sec | 1THz/sec | 1THz/sec | 160GHz/sec | 18GHz/sec |
|-------------|-----------|----------|----------|------------|-----------|
| RBW | 1MHz | 100kHz | 30kHz | 10kHz | 1kHz |

Amplitude Accuracy (+10dBm to Displayed Average Noise Level (DANL))

| 100kHz to 6GHz | >6GHz to 43.5GHz | RBW filter shape |
|--------------------|--------------------|--------------------|
| $\pm 2.0\text{dB}$ | $\pm 3.0\text{dB}$ | Flat-Top windowing |
| +2.0dB/-2.6dB | +3.0/-3.6dB | Nuttall windowing |

⁵Displayed Average Noise Level (DANL)

| Input Frequency Range | dBm/Hz |
|-----------------------|-----------------------------|
| 100 kHz to 160 MHz | -156 dBm |
| 160 MHz to 2.2 GHz | -159 dBm |
| 2.3 GHz to 24 GHz | -155 dBm |
| 24 GHz to 36 GHz | start -153 dBm + 0.5 dB/GHz |
| 40 GHz to 43.5 GHz | start -147 dBm + 1.1 dB/GHz |

LO Leakage at RF Input

-80dBm from 100kHz to 6GHz

-50dBm from 6GHz to 24GHz

-75dBm from 24GHz to 43.5GHz

⁵Residual Responses (Ref Level \leq -20dBm, 0dB Attenuation, 50-ohm load on RF input)

| Input Frequency Range | Residual Level (dBm) |
|-----------------------|----------------------|
| 100kHz to 6 GHz | -110 |
| 6 GHz to 15 GHz | -100 |
| 15 GHz to 43.5GHz | -90 |

⁵Spurious Responses (any ref level (RL) from +10dBm to -20dBm, in 5dB increments, input 10dB < RL, RBW \leq 30kHz, 40MHz IBW)

| Input Freq. Range | Spur Reject Off (dBc) | Spur Reject On (dBc) typical |
|-------------------|-----------------------|------------------------------|
| 100 kHz to 6 GHz | -55 | -75 |
| 6 GHz to 24 GHz | -45 | -75 |
| 24 to 43.5 GHz | -45 | -65 |

Sub-Octave Filtered Preselector

20MHz to 43.5GHz

⁵SSB Phase Noise at 1GHz Center Frequency

| Offset Frequency | dBc/Hz |
|------------------|--------|
| 10Hz | -76 |
| 100Hz | -108 |
| 1 kHz | -125 |
| 10kHz | -136 |
| 100kHz | -138 |
| 1 MHz | -138 |

⁵SSB Phase Noise at 20GHz Center Frequency

| Offset Frequency | dBc/Hz |
|------------------|--------|
| 1MHz | -112 |
| 10MHz | -131 |

Synchronization

GPS data in each packet with ± 40 ns time-stamping

FPGA

Altera 10AX027 has 1660 multipliers, provides selectable decimation, 160MHz of instantaneous bandwidth from FFT processing, and has resources to spare for future growth

Connectivity

⁴Local external computer with Microsoft Windows or Ubuntu Linux and one USB3.0 port is required to operate the SM435B (minimum of Intel 3rd Gen i7 processor or equivalent).

GPIO Port

Used for antenna switching and in/out triggering

GUI Languages

English, Simplified Chinese, Dutch, French, German, Italian, Japanese, Russian, and Spanish

⁸Operating Temperature (ambient)

Standard: 32°F to 122°F (0°C to +50°C) passive cooling

Option 1: -40°F to 149°F (-40°C to +65°C) active cooling & extended temperature

⁶Size

10.45" x 7.2" x 2.15" (259mm x 183mm x 55mm) passive cooling

10.45" x 7.2" x 2.74" (259mm x 183mm x 70mm) active cooling

Weight

8.15 lbs. (3.70 kg) passive cooling (**Standard**)

Power Consumption

9.51 lbs. (4.31 kg) active cooling (**Option 1**)

22 watts (when idling) or 32 watts (when sweeping or streaming I/Q) sourced from the AC wall adapter which is included or from an external supply of 9V to 16V when using the Option-12 LEMO Pigtail.

¹Dynamic Range is defined here as $\frac{2}{3}$ of the difference between IP_3 and DANL as measured in ITU-R SM.1837, normalized to dB/Hz

²For EVM measurements of signals having symbol rates between 100 kHz and 1MHz. The SM200A/B will contribute a somewhat higher EVM error for symbol rates outside of this range.

⁴Streaming I/Q and burst I/Q are bandwidth limited to the speed of the available Ethernet connection.

⁵DANL, Residual Responses, Spurious Mixer Responses, and Phase Noise specifications are production tested and guaranteed only at 23°C ($\pm 5^\circ\text{C}$). Typical performance of these characteristics, over the instrument's operating temperature range, will be published as graphs in the User's Manual.

⁶The SM200 length is 10.97" (0.77" longer) when counting the front panel type-N RF input connector and 0.375" higher when counting feet.

9 Warranty and Disclaimer

©2013-2020 Signal Hound. All rights reserved.

Reproduction, adaptation, or translation without prior written permission is prohibited, except as allowed under the copyright laws.

9.1 Warranty

The information contained in this manual is subject to change without notice. Signal Hound makes no warranty of any kind with regard to this material, including, but not limited to, the implied warranties or merchantability and fitness for a particular purpose. Signal Hound shall not be liable for errors contained herein or for incidental or consequential damages in connection with the furnishing, performance, or use of this material. This Signal Hound product has a warranty against defects in material and workmanship for a period of two years from date of shipment. During the warranty period, Signal Hound will, at its option, either repair or replace products that prove to be defective.

9.2 Warranty Service

For warranty service or repair, this product must be returned to Signal Hound. The Buyer shall pay shipping charges to Signal Hound and Signal Hound shall pay UPS Ground, or equivalent, shipping charges to return the product to the Buyer. However, the Buyer shall pay all shipping charges, duties, and taxes, to and from Signal Hound, for products returned from another country.

9.3 Limitation of Warranty

The foregoing warranty shall not apply to defects resulting from improper use by the Buyer, Buyer-supplied software or interfacing, unauthorized modification or misuse, operation outside of the environmental specifications for the product. No other warranty is expressed or implied. Signal Hound specifically disclaims the implied warranties or merchantability and fitness for a particular purpose.

9.4 Exclusive Remedies

The remedies provided herein are the Buyer's sole and exclusive remedies. Signal Hound shall not be liable for any direct, indirect, special, incidental, or consequential damages, whether based on contract, tort, or any other legal theory.

9.5 Certification

Signal Hound certifies that, at the time of shipment, this product conformed to its published specifications.

9.6 Credit Notice

Windows® is a registered trademark of Microsoft Corporation in the United States and other countries.

Intel® and Core™ are trademarks or registered trademarks of the Intel Corp. in the USA and/or other countries.

Ubuntu® is a registered trademark of Canonical, Ltd. in the United States and/or other countries.

10 Appendix A: Typical Performance

10.1 Sweep Speed (Fast)

This section refers to the "Fast Sweep" measurements of the SM device. For more information on this configuration see [Fast Swept Analysis](#).

The plot below shows the worst case sweep speed of the SM200 for a given span and RBW on a desktop PC using an Intel i7-4700 processor. Several factors influence the sweep speed of the device including

- Span, since the SM device uses 160MHz IF patches for fast sweep acquisitions, spans which make inefficient use of the available 160MHz IF's will experience a reduction in sweep throughput.

Appendix A: Typical Performance | Sweep Speed (Fast)

- RBW, lower RBWs require larger FFT sizes which increase the overall USB throughput and dwell times at each IF frequency.
- PC performance (less so when using the API directly), the Spike software performs trace averaging/maxholding as well as persistence and waterfall displays which can all contribute to lower sweep times. Generally for desktop processors we do not see slow down associated with this, but low power laptop processors can be the bottleneck for sweep speed.
- Center frequency, frequencies below 600MHz will slow the sweep down because the smaller IF bandpass filters at those frequencies prevent 160MHz of IF acquisition. Additionally, moving the center frequency while maintaining the same span might change which IF frequencies are used and might change how many are used.

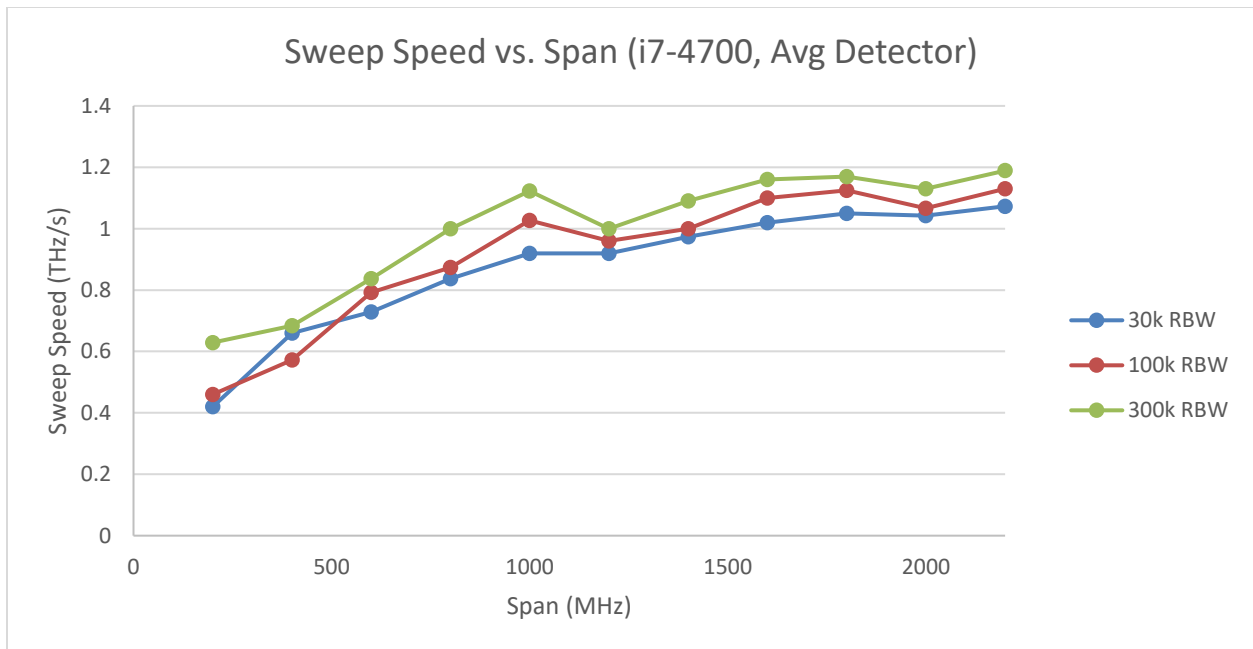

The SM435B has similar sweep speeds below 24 GHz, but may be slower than 1 THz/s for certain spans above 24 GHz.

10.2 SM200

10.2.1 VSWR

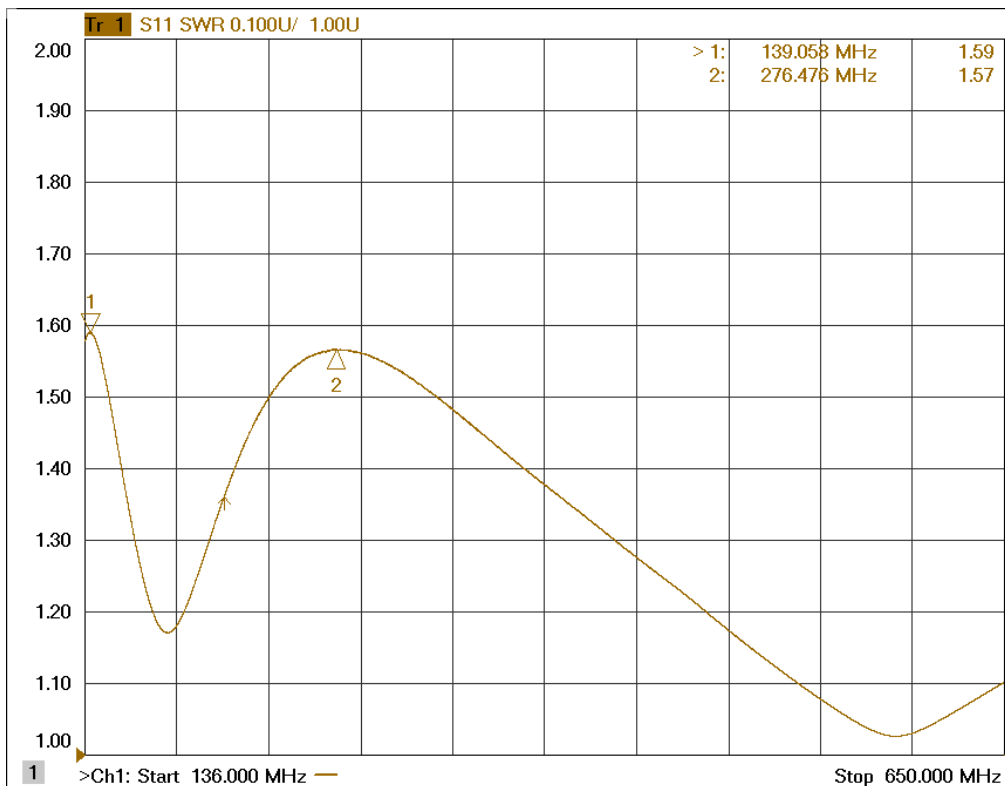
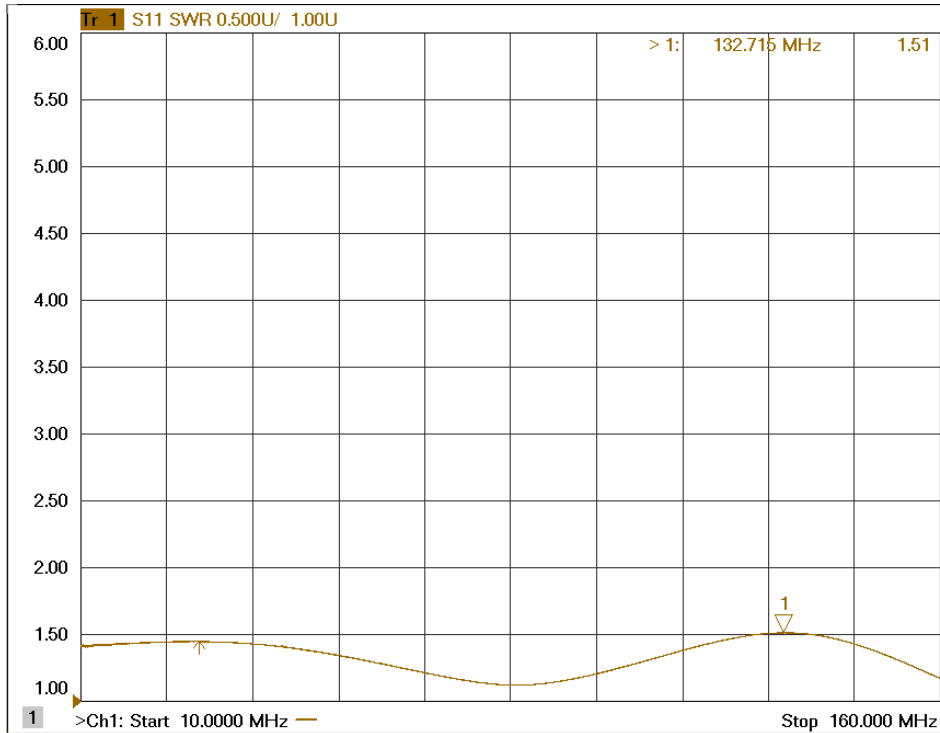

Appendix A: Typical Performance | SM200

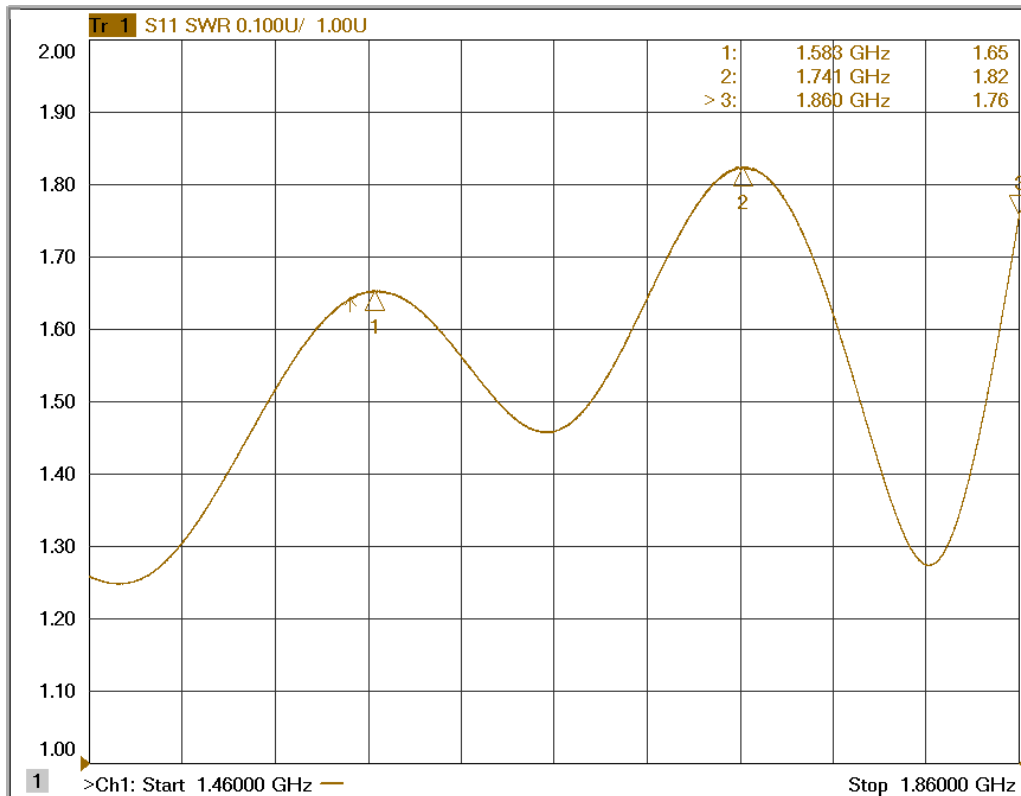
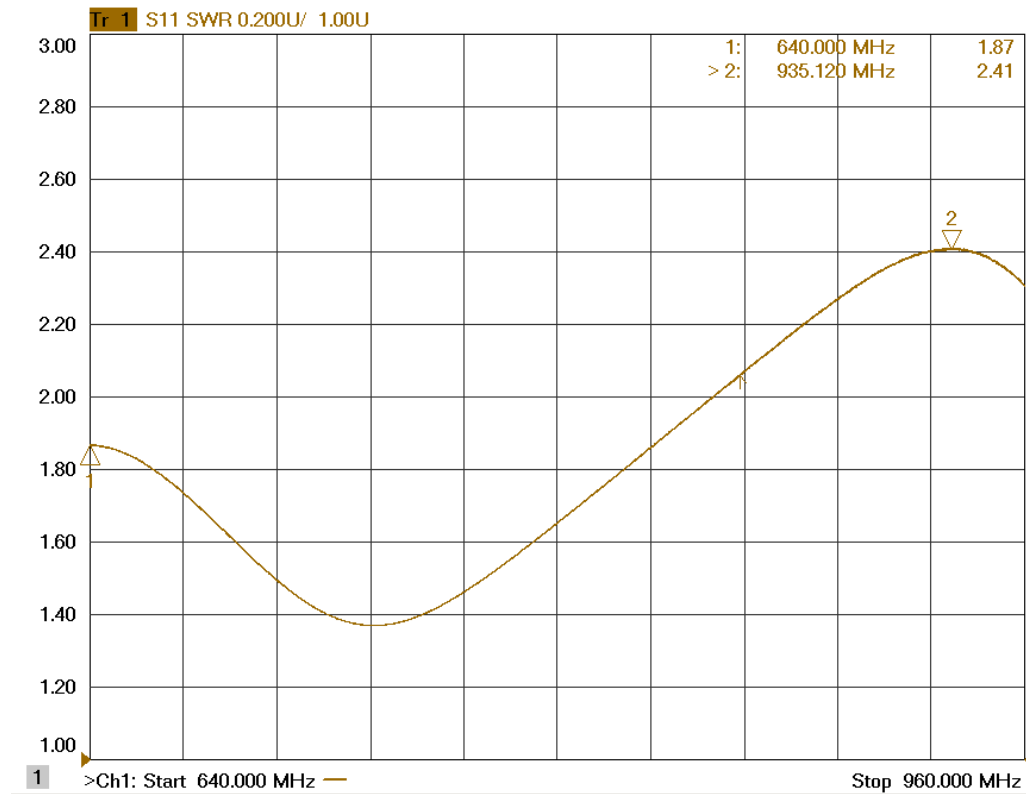

Appendix A: Typical Performance | SM200

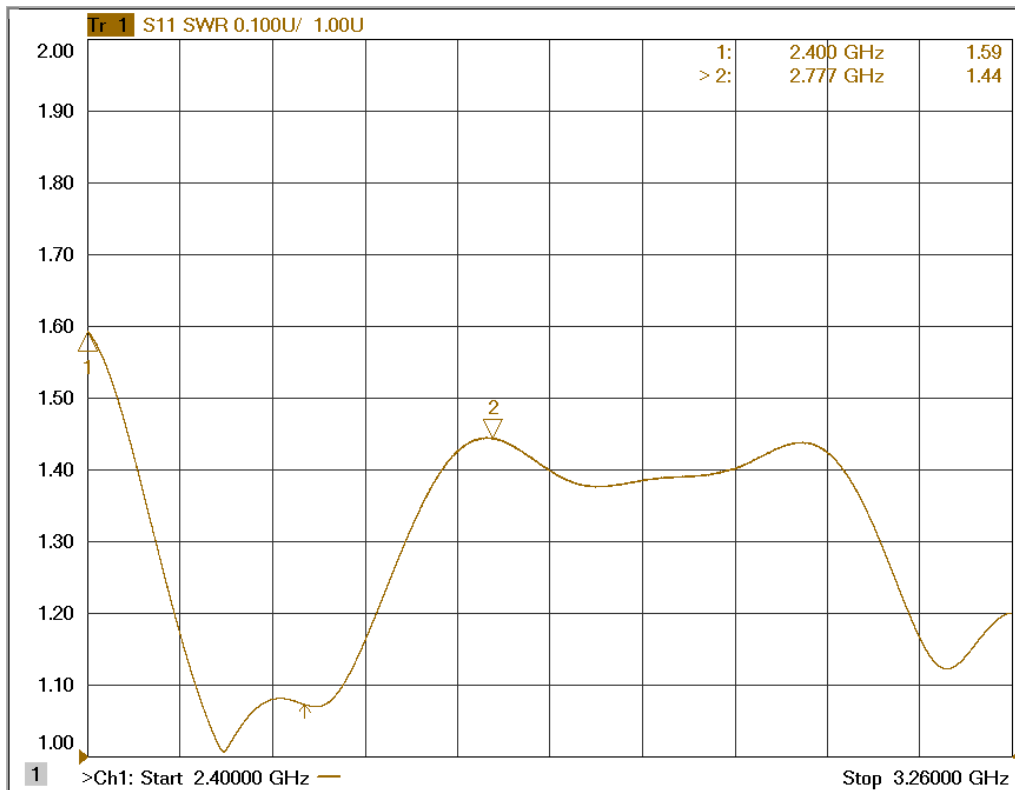
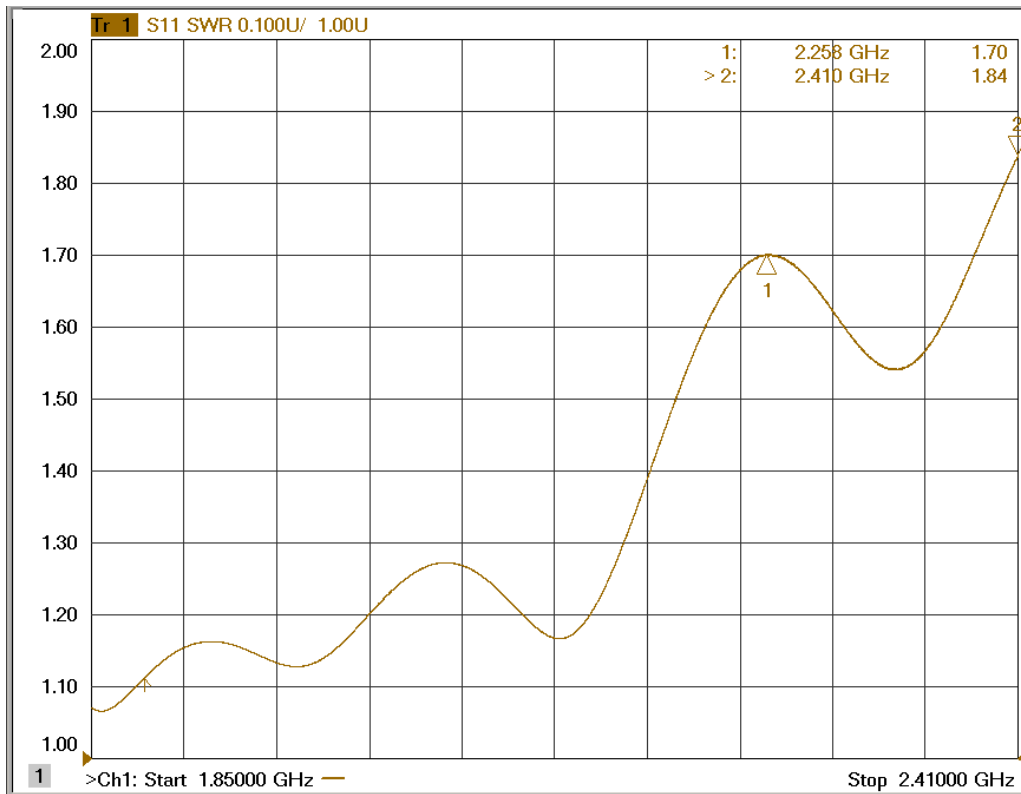

Appendix A: Typical Performance | SM200

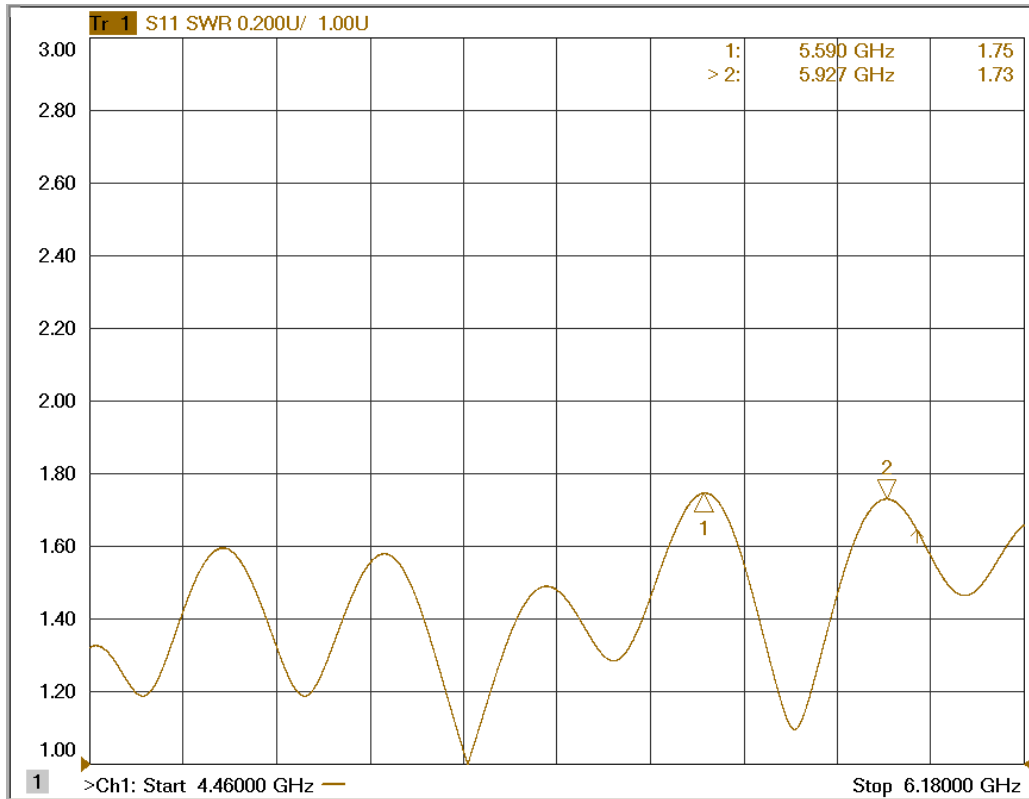
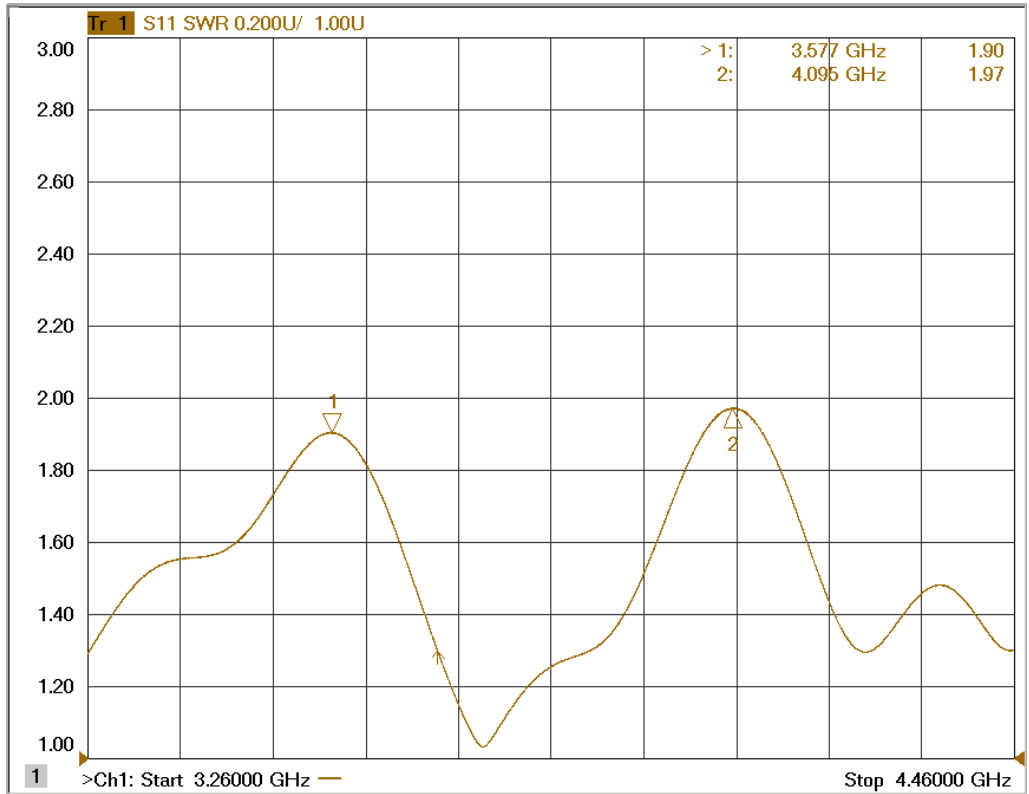

Appendix A: Typical Performance | SM200

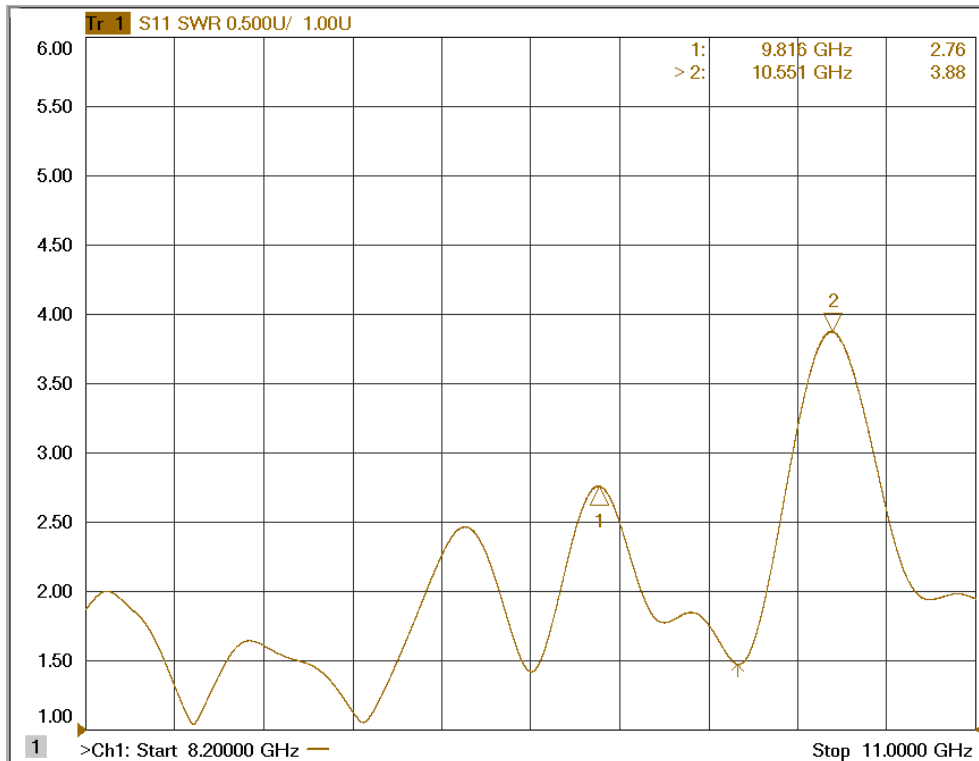
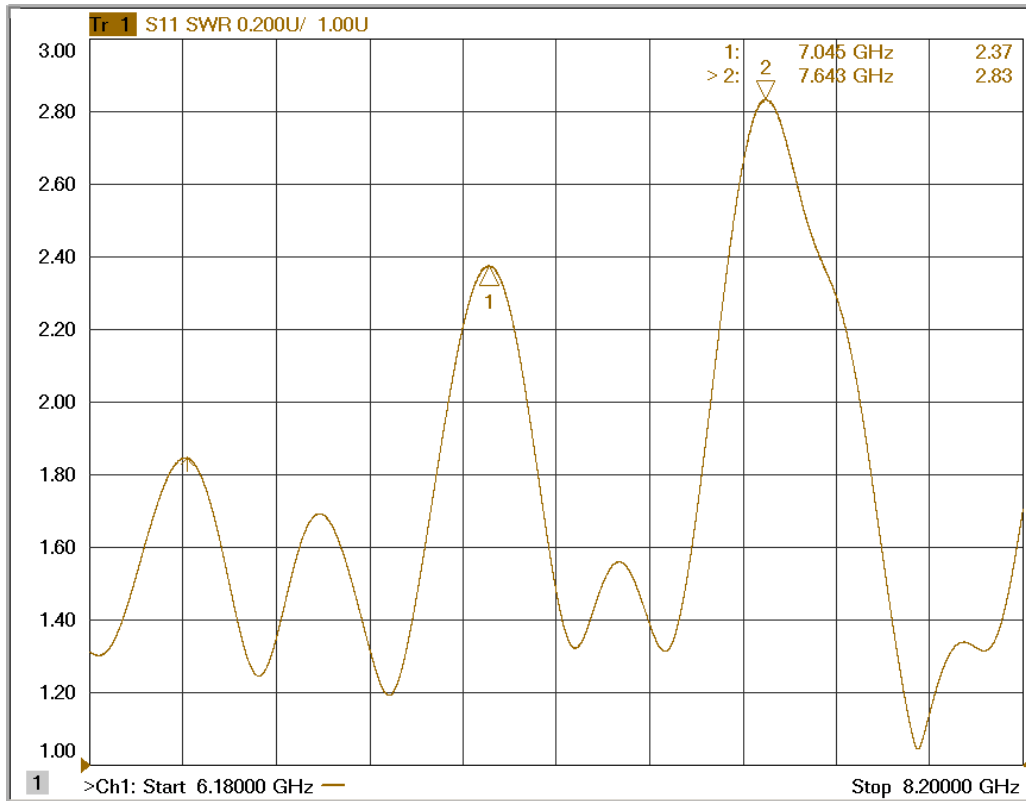

Appendix A: Typical Performance | SM200

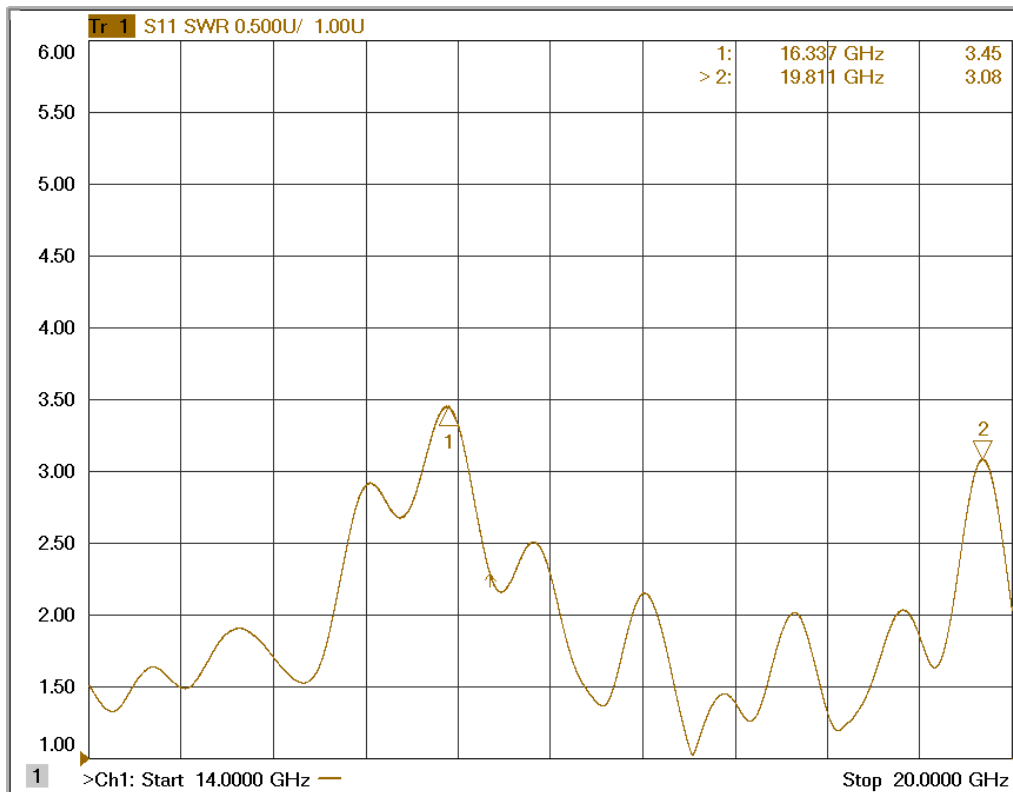
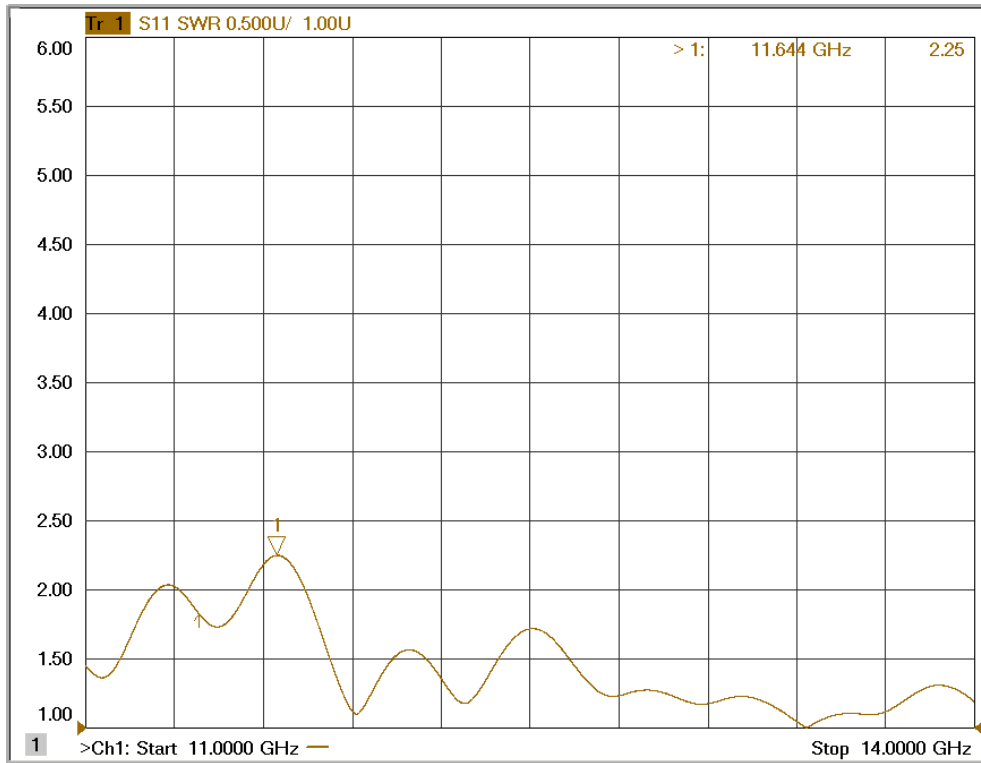

Appendix A: Typical Performance | SM435

Note: Where accurate measurements are required on a high VSWR signal source, a high quality 10 dB coaxial attenuator, such as a Keysight 8493C, will drastically reduce mismatch uncertainty and provide more accurate measurements.

10.2.2 Typical IP3

IP3 testing for receivers is typically run with preamplifier off, or a combination of preamplifier gain and attenuation equivalent to 0 dB gain. For the SM200, 20 dB of RF preamplifier gain and 20 dB of RF attenuation is achieved at 0 dBm reference level. Setup requires a directional coupler or other directional combiner to provide sufficient isolation between generators. Additionally, devices are tested at -10 dBm reference level and normalized to 0 dBm. Because the switch and attenuator linearity in the SM200 are much higher than the amplifier or mixer, this introduces minimal error, and requires only 15 dB of additional isolation between generators.

10.3 SM435

10.3.1 Typical Phase Noise

The table below shows the typical 1MHz and 10MHz phase noise performance at several carrier frequencies for the SM435.

| | 1 GHz | 5 GHz | 10 GHz | 20 GHz | 40 GHz |
|--------------|---------|---------|---------|---------|---------|
| 1MHz Offset | -141.22 | -128.05 | -121.89 | -115.71 | -109.35 |
| 10MHz Offset | -146.93 | -143.16 | -142.35 | -138.15 | -129.3 |

Typical phase noise performance at 1 GHz carrier frequency

| Offset (Hz) | 10 | 100 | 1k | 10k | 100k | 1M |
|----------------------|-----|------|------|------|------|------|
| Phase noise (dBc/Hz) | -86 | -112 | -130 | -139 | -142 | -141 |

For carrier frequencies above 1 GHz, add $20 \log_{10}(F/1 \text{ GHz})$ for typical performance.

10.3.2 Typical DANL (-20 dBm reference level)

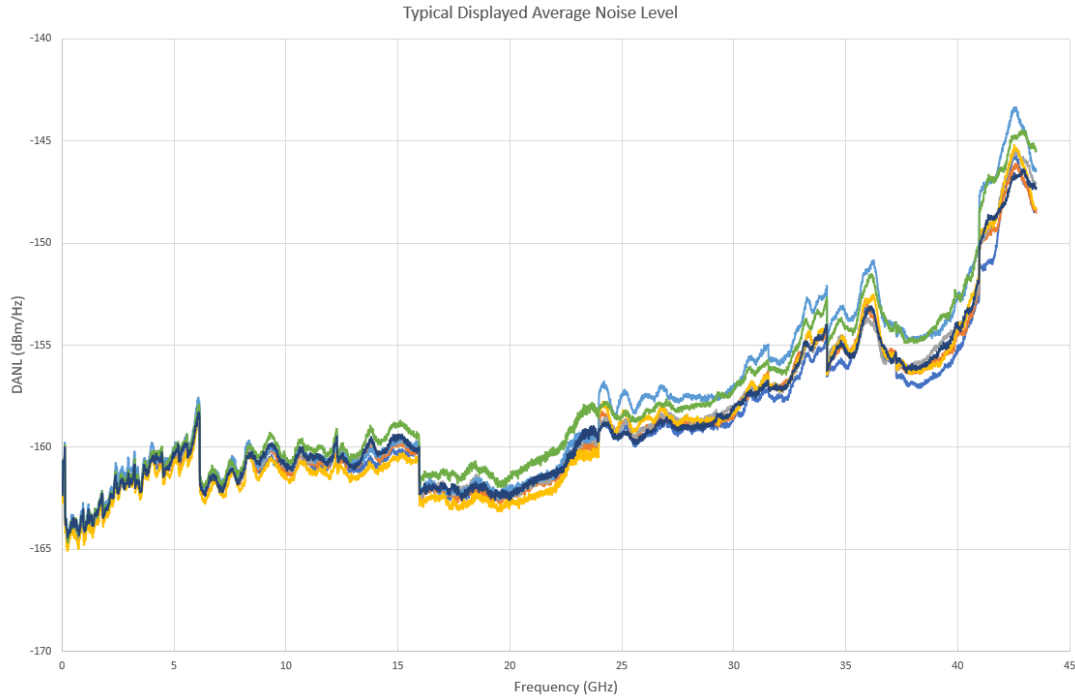

10.3.3 Typical IP2 (at 0 dBm reference level)

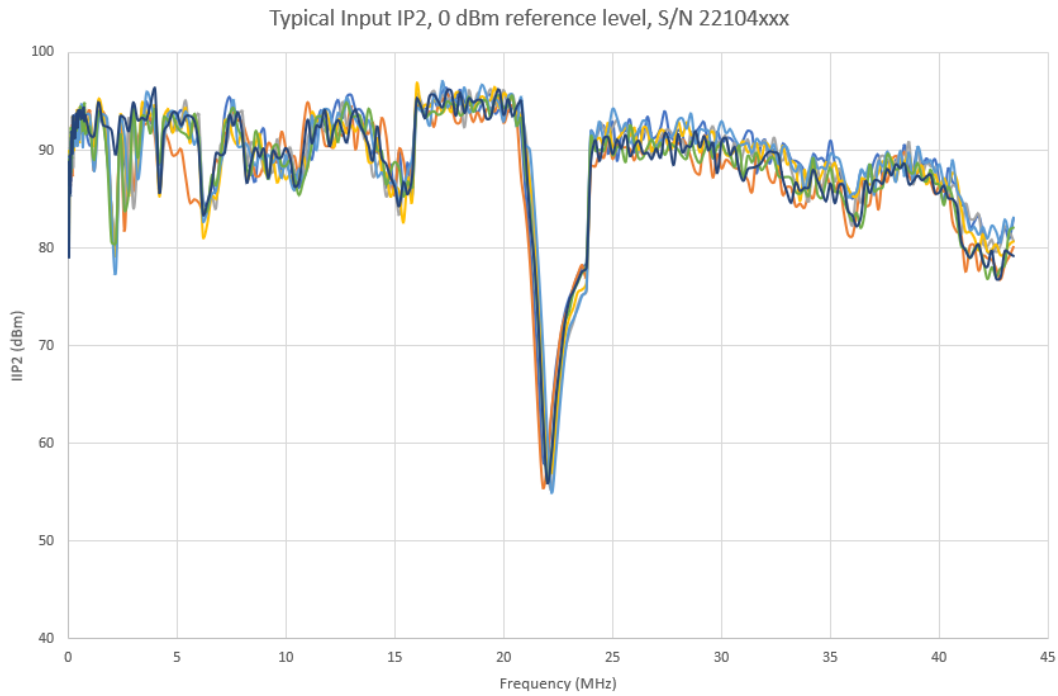

Note: Later serial numbers fix the 21-24 GHz notch in IP2 (>+88 dBm typical)

10.3.4 Typical Input IP3 (at 0 dBm reference level)

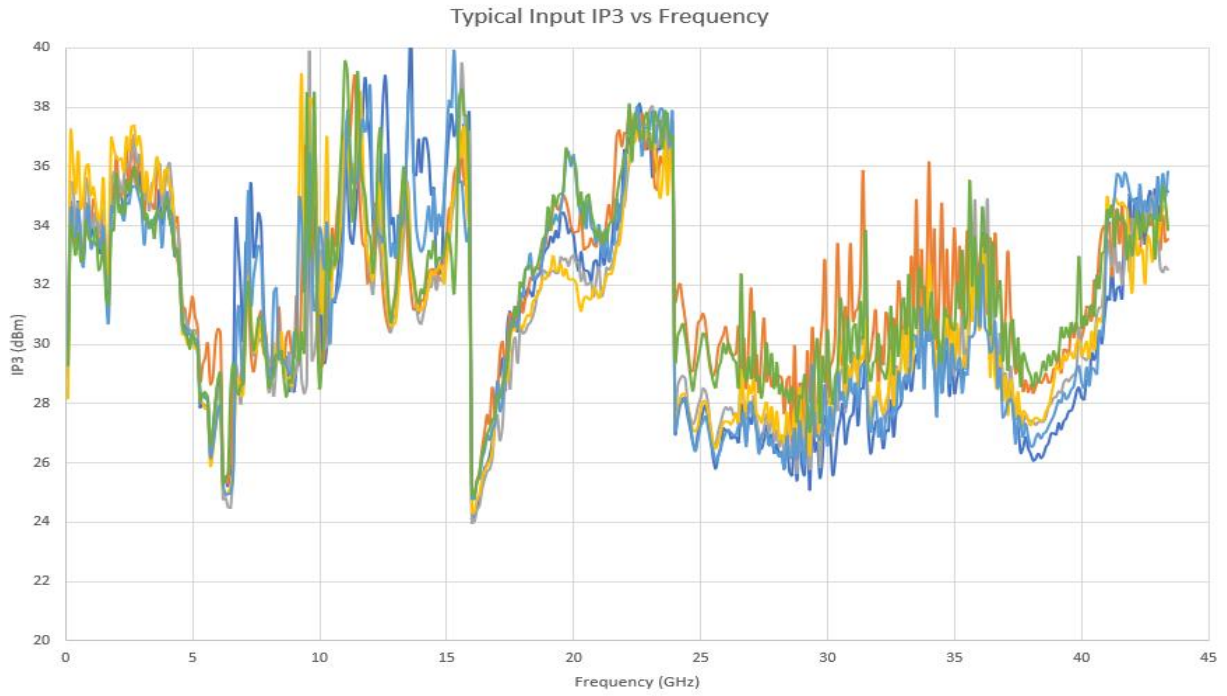

10.3.5 Typical LO Leakage

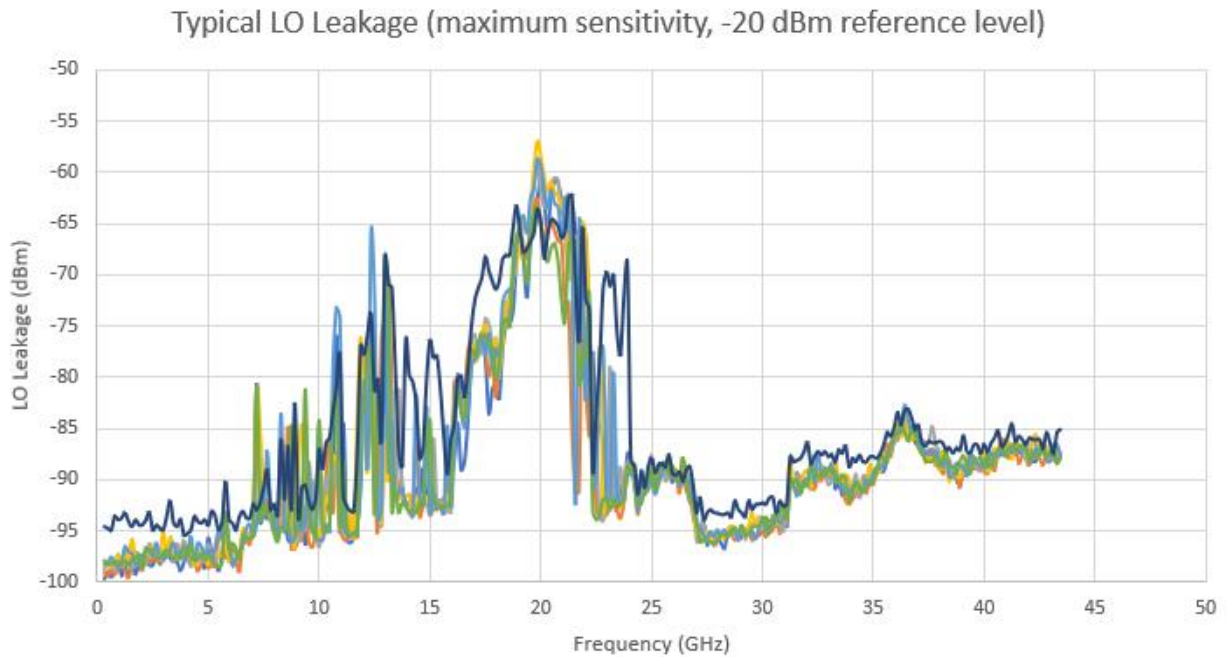

10.3.6 Typical VSWR

Typical VSWR vs Input Frequency (0 dBm reference level)

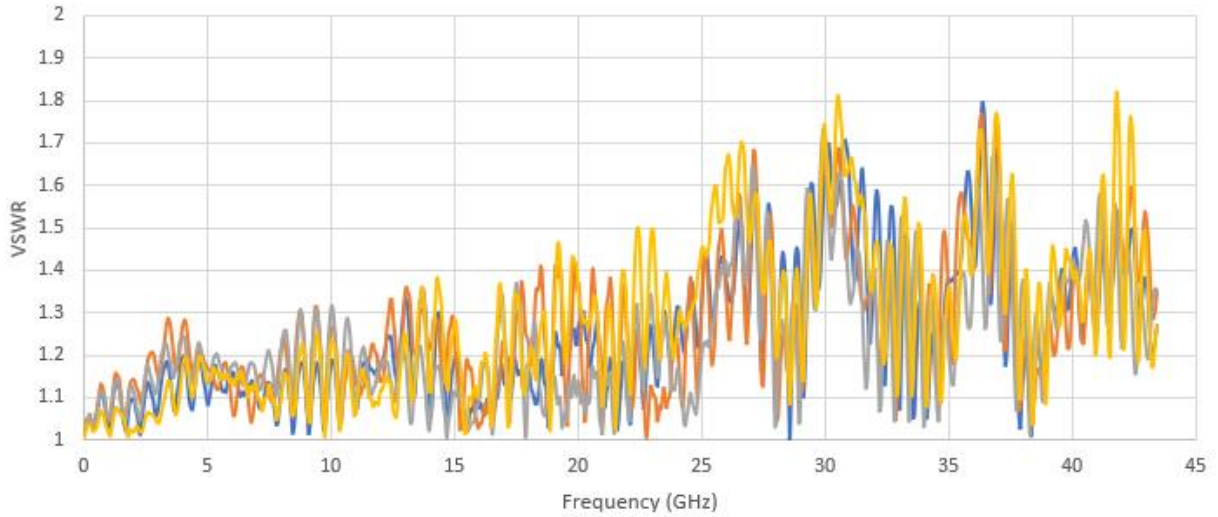

10.3.7 Typical Amplitude Accuracy

Typical Amplitude Accuracy, 0 dBm Reference Level

